

Client _____ Quantity _____
 Project _____ Position _____

Modi Active Blast Chiller

Model: W6A

Cod: W11066000001



Technical data

Top:	Thickness 4 cm. Reinforced in order to place an oven
Gross capacity:	160 lt
Temperature range:	-40°+65°C
Refrigerant unit:	Plug-In
Yield +90 / +3:	27 Kg
Yield +90 / -18:	21 Kg
Climate class:	5
Cooling gas:	R452A
Defrost:	Hot gas
Valve:	Electronic expansion valve
Dimensions:	780×800×913 mm
Packing dimensions:	800×830×955 mm
Gross weight:	130 Kg
Voltage:	220-240 V - 50 Hz
Total rate:	1670 W
Absorbed Current:	8,07 A
Cooling capacity:	2084 W*
*:	Evap. -10°C Cond. +45°C

Features

Functions:	Blast chilling, shock freezing, thawing, proving, holding, desiccation, chocolate, manual cycle
Standard equipment:	6 slides GN1/1, EN60x40
Control:	4,3" touch screen display with USB port
Doors:	Cushioned, with anti-odor system
Door gasket:	Magnetic, triple chamber and easily replaceable
Core probe:	Needle probe with 1 reading point, quick-release and easily replaceable
Insulation:	60 mm thickness - CFC/HCFC free
Exterior/interior finishing:	Exterior and interior AISI 304 stainless steel.
Inner corners:	Rounded for easy cleaning and ensuring maximum hygiene
Handle:	Stainless steel AISI 304, 2 mm thick
Racks and slides:	Stainless steel AISI 304, quick release
Feets:	Stainless steel AISI 304, adjustable h 100-150 mm

COSMO - wi-fi control

Cosmo is the innovative wi-fi technology that allows you to constantly connect and monitor from your smartphone the MODI blast chiller. MODI can also be a Cosmo hub and allow remote supervision of all Coldline devices connected to it. From the Cosmo app you can check the operating conditions of each machine in real time and receive alerts in the event of abnormal operation. Cosmo constantly compares the performance of the device with the ideal ones and, in case of significant differences, suggests the necessary maintenance. The MODI software can receive periodic updates released, with the latest features developed.



Technical draw

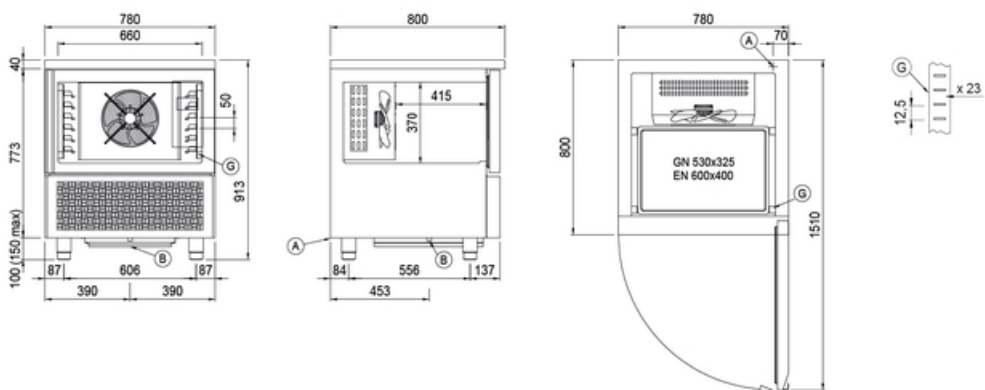

- A: Power supply cable outlet
- G: Racks pitch

- B: Condensation water drain

In order to constantly offer the best possible products we reserve the right to make changes on technical specifications without incurring any obligation for equipment previously or subsequently sold.