

# iBAKE

## Product Manual

Installation, use and maintenance



# INDEX

<b>1. INTRODUCTION .....</b>	<b>5</b>
<b>2. TECHNICAL CHARACTERISTICS.....</b>	<b>6</b>
2.1. Main characteristics Mychef iBAKE .....	6
<b>3. GENERAL SAFETY AND ACCIDENT PREVENTION REGULATIONS .....</b>	<b>7</b>
3.1. Personnel responsible for using the equipment.....	7
3.2. Electrical hazard .....	7
3.3. Thermal hazard.....	7
3.4. Corrosion hazard .....	8
<b>4. RECEPTION, TRANSPORT, AND POSITIONING .....</b>	<b>9</b>
4.1. Reception.....	9
4.2. Transport.....	9
4.3. Positioning .....	10
<b>5. INSTALLATION .....</b>	<b>12</b>
5.1. Electrical connection .....	12
5.1.1. Three-phase connection 400V 3L+N .....	13
5.1.2. Three-phase connection 230V 3L.....	13
5.1.3. Single-phase connection 230V L+N .....	14
5.2. Water connection.....	14
5.2.1. Water input .....	14
5.2.2. Drain .....	15
5.3. Vapour condensation hood.....	16
<b>6. INICIAL REGISTRATION .....</b>	<b>17</b>
6.1. Mychef iBAKE startup .....	17
<b>7. USE.....</b>	<b>22</b>
7.1. Mychef iBAKE .....	22
7.1.1. Switching on the equipment.....	22
7.1.2. First use.....	22
7.1.3. Main menu .....	23
7.1.4. Mychef iBAKE main functions .....	24
7.1.5. Navigation .....	26
7.2. Chef .....	27
7.2.1. Cooking options.....	28
7.2.2. Chef Menu.....	30
7.2.2.1. Temperature cooking and time control.....	33

7.2.2.2. Editing cycles .....	39
7.2.2.3. Initiate cooking .....	40
7.2.2.4. End of cooking.....	42
7.3. SmartCooking .....	43
7.3.1. SmartBaking mode.....	44
7.3.1.1. Go & Cook.....	46
7.3.1.2. Save a cooking configuration or create a recipe .....	47
7.4. CookingPlanner .....	49
7.4.1. Save CookingPlanner.....	52
7.5. Regenerate .....	53
7.6. MyCare .....	56
7.7. Recipes.....	63
7.7.1. Recipes .....	64
7.7.2. My Recipes .....	65
7.7.3. By ingredients.....	66
7.7.4. Managing recipes from Mychef Cloud .....	67
7.8. Settings.....	68
7.8.1. Date/time.....	69
7.8.2. Language.....	70
7.8.3. Volume.....	71
7.8.4. Lighting.....	72
7.8.5. Smart Assistant .....	73
7.8.6. Maintenance .....	74
7.8.7. Probe .....	76
7.8.8. System Analysis .....	77
7.8.9. System .....	78
7.8.10. Restore factory default values .....	78
7.8.11. Accounts .....	79
7.8.12. USB.....	80
7.8.13. Consumption.....	81
7.8.14. Measurement system .....	83
7.8.15. Advanced settings.....	84
7.8.16. NightWatch .....	85
7.8.17. Errors and alarms.....	86

**8. MAINTENANCE ..... 89**

- 8.1. Cleaning..... 89
  - 8.1.1. Cooking chamber..... 90
  - 8.1.2. Stainless steel exterior surfaces ..... 91
  - 8.1.3. Fan and heat exchanger zone..... 91
  - 8.1.4. Plastic outer surfaces and control panel..... 92
  - 8.1.5. Door gasket..... 92
  - 8.1.6. Tray Support ..... 93
  - 8.1.7. Door glasses ..... 94
- 8.2. Periods of inactivity..... 95
- 8.3. Disposal at the end of the useful life..... 95
  - 8.3.1. Information on disposal in Spain ..... 96
  - 8.3.2. Information on Disposal in the European Union ..... 96
- 8.4. Preventive maintenance ..... 96

## 1. INTRODUCTION

This manual has been carefully prepared and reviewed to provide reliable information and assistance for proper installation, use, and maintenance that will ensure proper operation and prolong the life of the oven. This manual is divided into three parts, the first part is dedicated to the installation of the equipment at the working point, the second part is focused on the use, and the third part is on the cleaning and maintenance of the oven.



***Before any intervention or use of the equipment, it is necessary to read this manual carefully and completely.***

The manufacturer declines all implicit or explicit responsibility for any errors or omissions it may contain.

- The oven may not be used by personnel who have not received any kind of training, and who do not have the necessary skills or experience for the proper functioning of the equipment. Do not let children use or play with the equipment.
- The owner of the equipment is obliged to have this manual read by personnel responsible for its use and maintenance and to keep this manual in a safe place for use by all users of the equipment and for future reference. If the equipment is sold to others, they must be given this manual.
- This oven must only be used for its intended purpose, i.e., cooking, heating, regenerating or dehydrating food. Any other use can be dangerous and can result in personal injury and property damage.
- The equipment is shipped from the factory once it has been calibrated and has passed rigorous quality and safety tests that ensure its correct operation.



***The manufacturer will disclaim any responsibility for problems caused by improper installation, modification, use or maintenance.***

## 2. TECHNICAL CHARACTERISTICS

### 2.1. Main characteristics Mychef iBAKE

	<b>4 600x400</b>	<b>6 600x400</b>	<b>10 600x400</b>
<b>Exterior dimensions (width x depth x height) (mm)</b>	760x800x750	760x800x865	760x800x1155
<b>Capacity</b>	4 600x400	6 600x400	10 600x400
<b>Distance between guides (mm)</b>	85mm	85mm	85mm

**Table 1. Main characteristics of Mychef iBAKE ovens**

The maximum recommended food load per 600x400 tray is 5 Kg.

### 3. GENERAL SAFETY AND ACCIDENT PREVENTION REGULATIONS

#### 3.1. Personnel responsible for using the equipment

The use of the equipment is reserved for trained personnel.



***Personnel who perform any action on the oven, such as operation, cleaning, installation, handling, etc., must be familiar with the safety regulations and the Operating Instructions.***



***Do not allow unauthorized personnel to use, handle or clean the equipment.***

#### 3.2. Electrical hazard

Work on the electrical supply side and access to live parts may only be carried out by qualified personnel under their own responsibility. In any case, such access must be made with the equipment disconnected from the power supply.

If the appliance is placed on a cart or on tables that have some mobility, do not allow it to move while connected to the power supply to avoid possible damage to wiring, drainage pipes or water inlets. If the equipment is to be moved or repositioned, the cables and the drainage and water intake pipes must be disconnected.

#### 3.3. Thermal hazard

When the equipment is in operation, the door should be opened slowly and carefully to avoid possible burns from steam or hot air that may escape from inside the cooking chamber.



***Keep the ventilation openings free of obstacles. Do not install the equipment in the vicinity of flammable products. Avoid positioning the oven near heat sources such as stoves, grills, fryers, etc.***

***Check the safety distances in chapter Positioning.***



***DANGER OF ACCIDENT! Be careful when using food containers in the oven when the top tray is 160 cm or more high. There is a risk of injury caused by the hot contents of the trays.***



***While the oven is in operation, avoid touching metal parts and the door glass as they may exceed 60°C. Touch only the handle and the control panel.***

### 3.4. Corrosion hazard

When using cleaning products, special attention and appropriate safety measures should be taken when handling these products. Always read the safety data sheet for the different chemicals before use and follow the instructions for use. These products in contact with any part of the body are abrasive and can cause skin and eye irritations and causticity.

During cleaning of the oven and in the event of aerosols or mist forming when handling cleaning products, wear a mask with a P2 / P3 type particle filter, goggles for protection against splashes and/or splashes and chemical protection gloves.

MyCare CleanDuo and DA21 cleaning products have been specially formulated for the correct cleaning and protection of Mychef ovens with automatic washing. The product contains, in addition to detergent, polish for a perfect finish. The use of this detergent is mandatory in the Mychef iBAKE ovens



***Use CleanDuo in the Mychef iBAKE ovens equipped with the automatic washing system. The use of other products will void the warranty.***



## 4. RECEPTION, TRANSPORT, AND POSITIONING

Before carrying out the installation, the dimensions of the site where the equipment is to be placed and the electrical and water connections must be verified and seen to be within the parameters detailed in section 4.3.

### 4.1. Reception

Once the oven has been received, check that the model purchased corresponds to the order.

Check that the packaging has not been damaged during transport and that no parts of the equipment are missing. If you detect any anomaly or problem, contact your dealer immediately.

### 4.2. Transport

The equipment should be transported in its original packaging to the closest location to the point of installation to avoid damage as much as possible. It is recommended to keep the original packaging until the equipment is properly installed and in operation.

To move the equipment and place it in your workspace, the following observations should be taken into account:

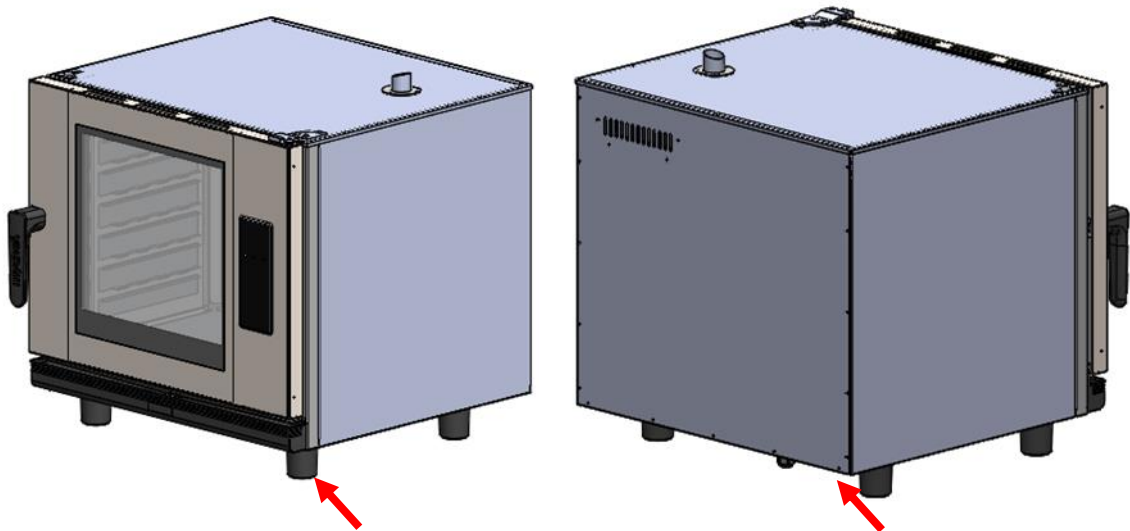
- The measurements of the different models to pass through narrow places (corridors, doors, narrow spaces). See chapter 2.
- The handling must be done with the necessary personnel to move the load of the furniture taking into account the current occupational safety regulations at the place of installation.
- The oven must always be in an upright position during transport. It must be lifted perpendicularly to the ground and transported parallel to it.
- Make sure that during transport it does not tip over and is not hit by any object.



***Be careful with the legs and the siphon when positioning the oven on the final location.***

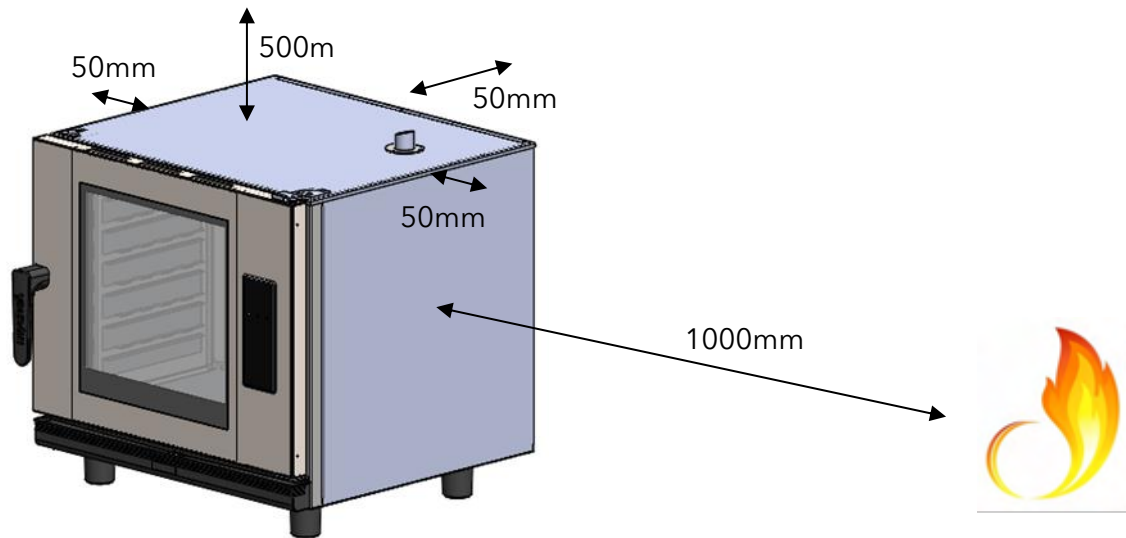
### 4.3. Positioning

- Place the oven at a comfortable distance from the wall so that the electrical and water connections can be made. There must be a minimum clearance from the oven parts to allow for proper ventilation and cooling. This minimum distance is:
  - o 50mm on the left and right sides
  - o 50mm from the back
  - o 500mm from the top
- The equipment should be placed on a Mychef support table or wall mount.
- If there are sources of heat or steam near the equipment (stove, grill, iron, deep fryer, pasta cooker, kettle, tilting frying pan etc.), these must be at a distance of more than 1 meter.
- Check that the oven is not exposed to hot air or vapors in the areas where the cooling fans are located (front right and rear left).



**Figure 1. Suction areas for cooling**

- Once it is placed in the workspace, check that it is level.



**Figure 2. Example of a suitable location for installation**



***Be extremely careful with the cooling areas of the oven. If it sucks in vapors or hot air it can drastically reduce the life span of the components.***



***For the installation of Mychef stacked ovens, follow the instructions supplied with the corresponding stacking kit.***

## 5. INSTALLATION

### 5.1. Electrical connection

Check that the voltage reaching the point where the oven is to be switched on corresponds to the operating voltage of the equipment.

The following table indicates the electrical characteristics of each oven:


	Voltage	Power (kW)	Rated current (A)	Cross-section cable (mm <sup>2</sup> )
<b>6 GN 1/1</b>	400/3L+N/50-60	9.3	14.3	1.5
	230/3L/50-60	9.3	24.8	2.5
<b>10 GN 1/1</b>	400/3L+N/50-60	18.6	28.7	4.0
	230/3L/50-60	18.6	49.6	10.0
<b>6 GN 2/1</b>	400/3L+N/50-60	18.6	28.7	4.0
	230/3L/50-60	18.6	49.6	10.0
<b>10 GN 2/1</b>	400/3L+N/50-60	27.9	43.0	10.0
	230/3L/50-60	27.9	74.5	35.0

**Table 2. Electrical connection characteristics**

Before carrying out any electrical work, make sure that no electrical current is supplied at the point of connection of the equipment.

The device must be connected to the mains via an all-pole switch with a contact opening distance of more than 3mm. Also install a class A differential device and an overcurrent protection.

Always ensure effective grounding.

Connect the equipment to an equipotential bonding system  using the contact specially provided for this purpose (see equipotential bonding sign on the bottom left of the equipment). If two pieces of equipment are stacked, both must be connected to the equipotentiality system.



***The connection to an equipotential system guarantees additional safety in case of simultaneous earth leakage and differential failure.***

The wiring and other safety devices used for the electrical installation must have the appropriate section for the equipment in question.



***In any case, respect the regulations in force for the connection of the equipment to the low voltage network.***

Before starting the electrical installation, check that the electrical requirements of the oven and the power supply are the same.



***Never connect a phase to neutral or ground. Check that the installation voltages correspond to those of the equipment.***

The following subchapters show the three possible types of connections for Mychef ovens. The voltage of each oven can be found on its identification sticker.

### 5.1.1. Three-phase connection 400V 3L+N

Color		Cable
■	Brown	L1
■	Black	L2
■	Grey	L3
■	Blue	Neutral
■	Green-yellow	Grounding

**Table 3. Three-phase cable 400V 3L+N**

### 5.1.2. Three-phase connection 230V 3L

Color		Cable
■	Brown	L1
■	Black	L2
■	Grey	L3
■	Green-yellow	Grounding

**Table 4. Three-phase cable 230V 3L**

### 5.1.3. Single-phase connection 230V L+N

Color		Cable
■	Brown	L1
■	Blue	Neutral
■	Green yellow	Grounding

Table 5. Single-phase connection 230V L+N

## 5.2. Water connection

### 5.2.1. Water input

Cold water (max. 30°C) ¾ inch 150 to 400 kPa dynamic flow pressure.

Drinking quality water with the following characteristics:

- Hardness between 3° and 6° FH
- PH between 6.5 and 8.5
- Chlorides (Cl-) less than 30 mg/L
- Chlorine (Cl2) less than 0.2 mg/L
- Iron (Fe) less than 0.1 mg/L
- Manganese (Mn) less than 0.05 mg/L
- Copper (Cu) less than 0.05 mg/L
- Conductivity less than 20uS/cm

Use of descaler and Mychef filter mandatory.

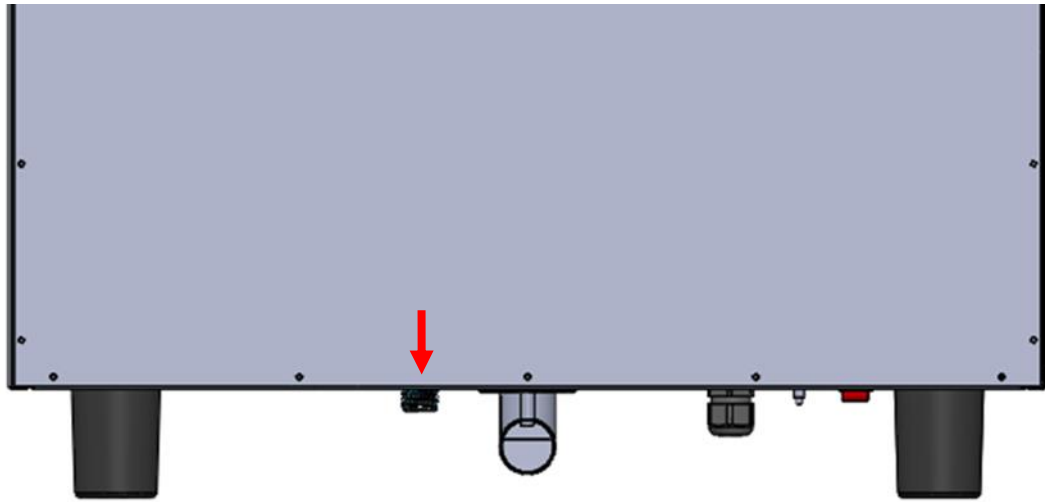


***The use of water with different characteristics than those indicated may cause serious problems in the components of the oven, such as corrosion in the cooking chamber or the glass, premature failure of the solenoid valves, etc.***



***Periodically check the quality of the water in the oven.***

The oven has a water inlet ¾" at the back of the oven for steam generation and for self-cleaning processes.



**Figure 3. Water intake**

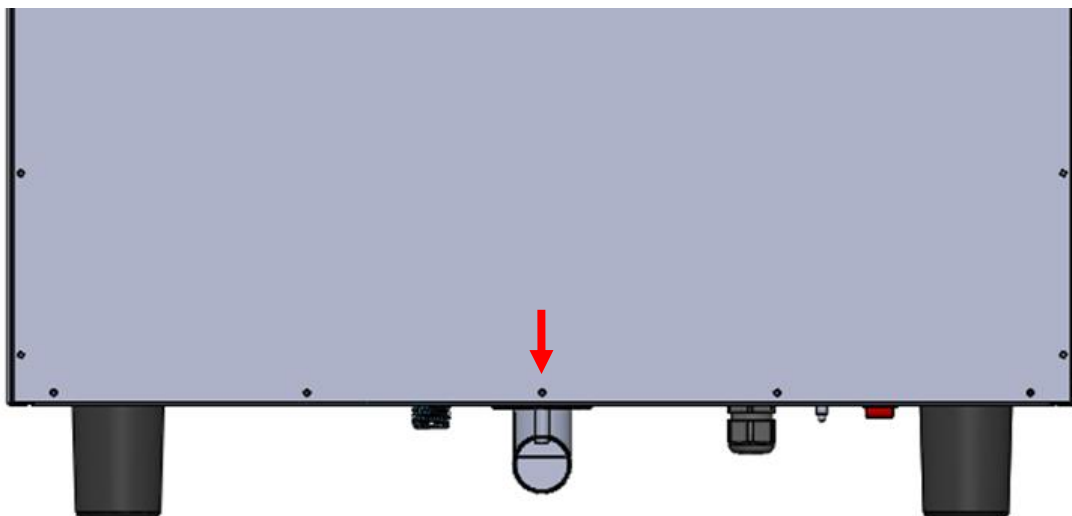


***In the case of a new installation, the water must be left to run until the connection is completely purified. This operation must be repeated each time work or repairs are carried out on the water system that feeds the oven.***

### **5.2.2. Drain**

For the correct operation of the steam system of the iBAKE ovens, the equipment must be connected to a drainage system with a nominal diameter of 40mm (DN40) through a heat-resistant, siphon-type pipe.

The Mychef iBAKE oven incorporates an internal system to block any odors that may come from the drain.



**Figure 4. Drainage**

For correct operation, bear in mind that the pipe must have a constant slope of at least 5°.



***The drain must be a maximum of 1 meter long, have a diameter greater than the drain connection and be free of bottlenecks.***

### **5.3. Steam condensation hood**

Refer to the installation manual supplied with the steam hood for installation.



***The steam condensation hood is an optional extra. The hood can be installed once the oven is installed.***

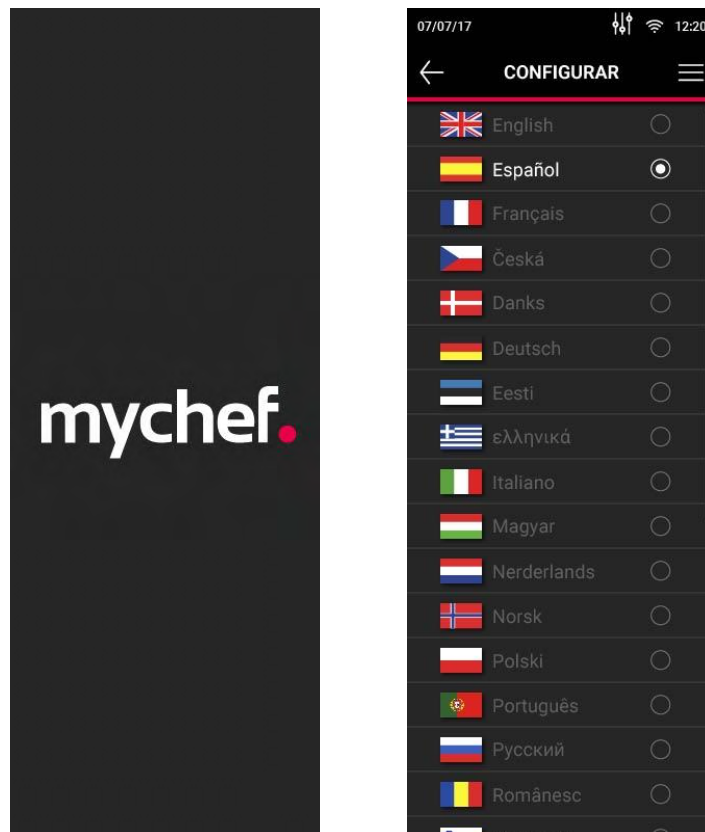


## 6. INICIAL REGISTRATION

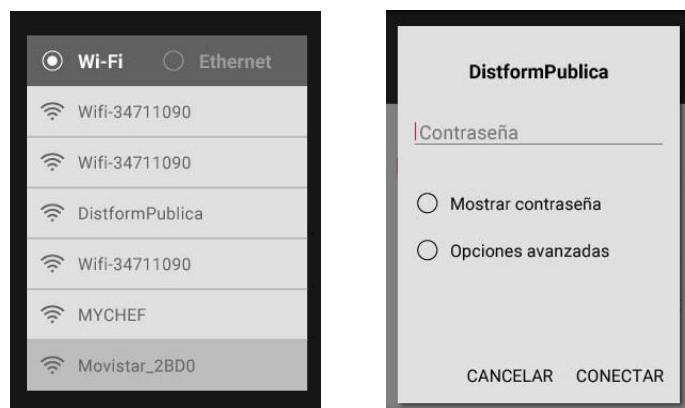
### 6.1. Mychef iBAKE startup

This short instruction is intended to explain the steps to follow to start the Mychef iBAKE oven for the first time.

1. Turn on the oven. Then select a language and press "Done".

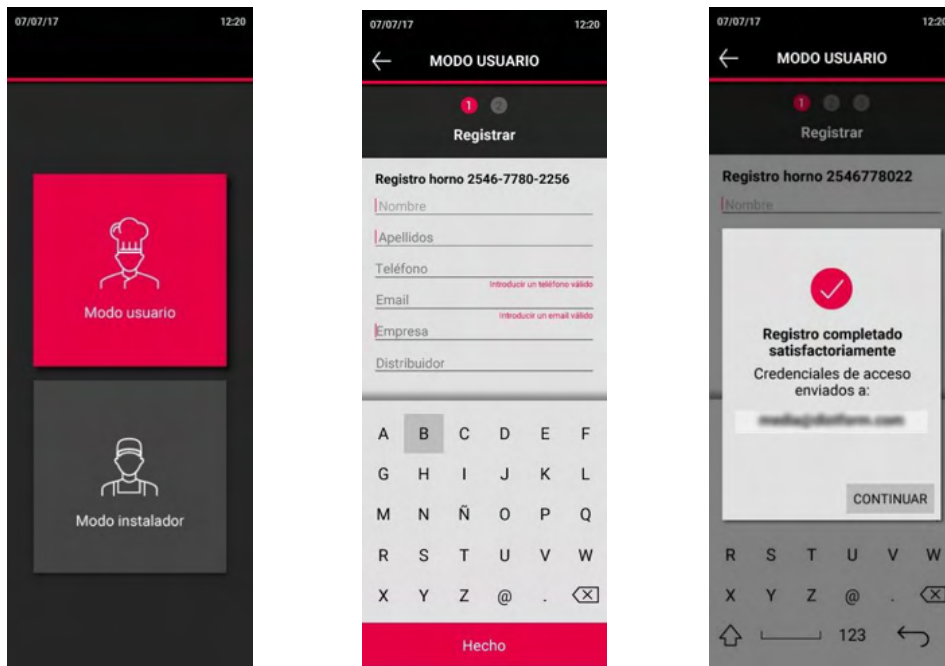


2. Choose the Wi-Fi network and enter the password to connect:



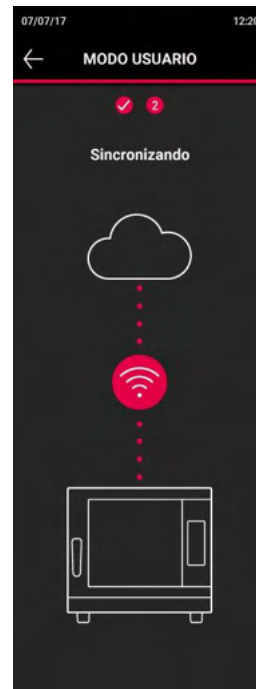
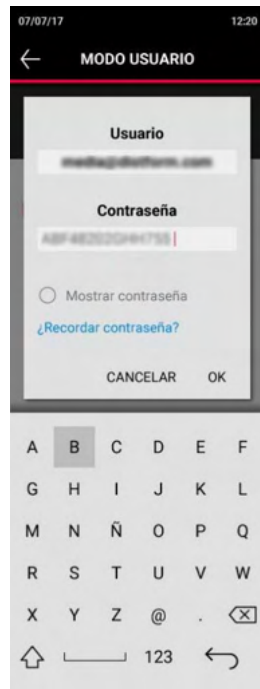
- a) The oven does not connect to the Wi-Fi network:  
Make sure the router is working and that the password is correct.
- b) If the Wi-Fi network is currently not available:  
You can use the mobile phone as an access point to connect (Internet Hotspot mode).

3. Choose "User Mode" to create an account and register the oven.



- Make sure you enter a valid email address to receive the access credentials.
- All fields must be completed.

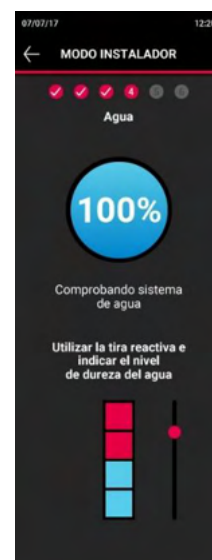
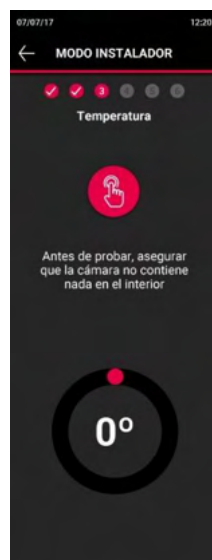
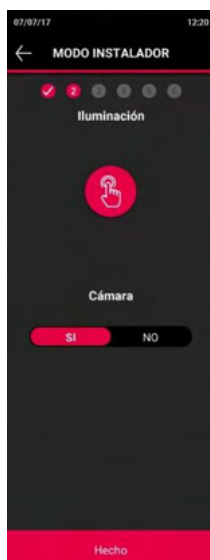
4. If you already have a user account: enter the email address and password. The oven will sync.



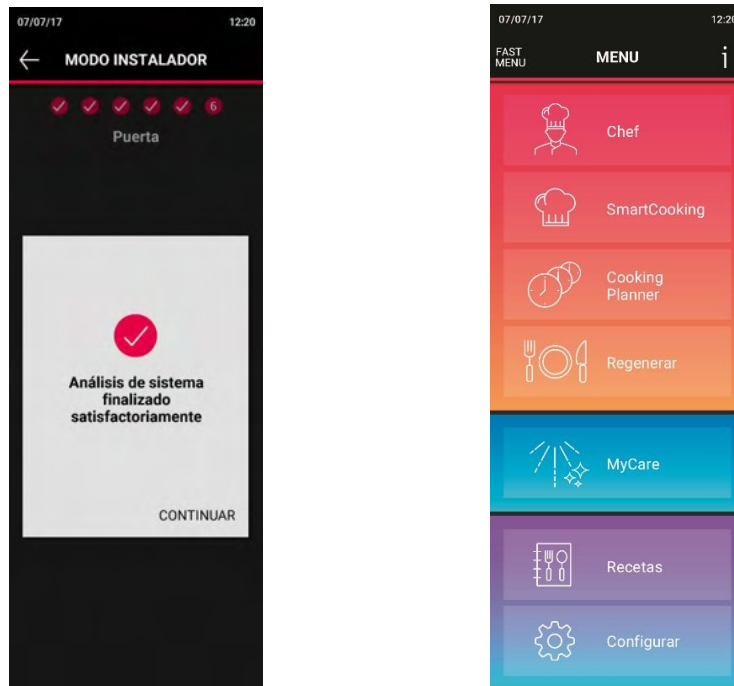
5. Access the "Installer Mode" and complete the fields with the required data.

6. System analysis

The oven will begin a general check to make sure the installation was done correctly. Follow the onscreen prompts.



7. Once the system scan has completed successfully, the system will initialize, and the main menu will be displayed.



## 8. Access to the Mychef Cloud App

With the credentials received via email, it is possible to access the Mychef Cloud application from where it will be possible to synchronize with the cloud and carry out more advanced management of the oven. From the application it is possible:

- Edit your own recipes with ingredients, preparation steps, cooking and plating steps, as well as add photos.
- Access to the Mychef recipes database, created by and for Chefs.
- Recalculation of costs based on the number of diners.
- Synchronization of recipes from the app with the Mychef ovens.
- Simultaneous Multilevel cooking programming.
- Simultaneous JustInTime cooking programming.
- Information on each associated oven.
- Remote supervision of the status of each oven (cooking, washing, programming, etc.).
- Control of water and energy consumption by periods.

- Visualization of HACCP graphics.
- Management of fast access programs FastMenu.
- Remote activation / deactivation / replication of FastMenu mode in one or more ovens.
- Language settings

The app is available for both Android and iOS devices.



## 7. USE

This section provides an overview of the basic functions and all the information necessary for the correct use of the user interface of the Mychef iBAKE combi oven.

For a description of more specific functions, refer to the help available on each screen.

### 7.1. Mychef iBAKE

#### 7.1.1. Switching on the equipment

The equipment is switched on or off using a switch located on the bottom rear.

Once turned on, the system can be turned off or on using the circular button START / STOP on the control panel. Turning off from the circular button START / STOP the system will remain in standby mode. To turn off completely it is necessary to use the switch.



***In order to protect the oven from possible overheating, some protective elements may work even if the oven is switched off. When the oven is at a safe temperature, they will turn off automatically.***

#### 7.1.2. First use

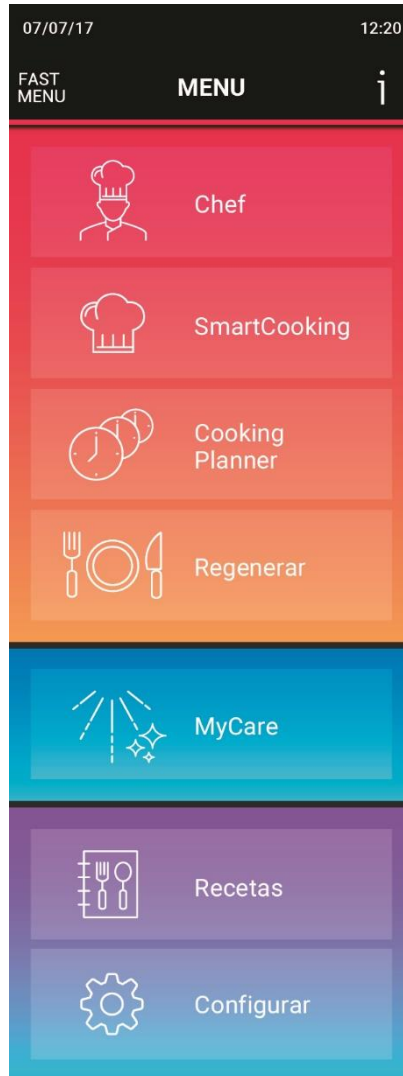
Once you have connected your Mychef oven for the first time, you will need to access the Wi-Fi network to synchronize with the cloud. A check on available software updates and if necessary, the download and update of the system will then be executed.

After the software has been checked, the user interface will guide you through the "User Mode" option for registering the oven, so that you can receive personalized assistance from the Mychef service department.

In order to start using the oven, it will also be necessary for the installer to register, to check the serial number, to verify the functionalities of the oven and to ensure that the installation has been carried out correctly. To do this, the installer must select the "Installer Mode" option and follow the steps marked by the user interface.


### 7.1.3. Main menu

Each time you start the oven after initial setup, you will be taken directly to the main menu shown in the picture below.



**Figure 5. Main menu display**

This menu is structured in three main sections:

 Cooking (Chef, SmartCooking, CookingPlanner, Regenerate)

 Self-cleaning (Mycare)

 Recipes and Settings

The main functions shown in the menu are as follows:



**Chef** - Cooking with manual mode parameter settings



**Mychef** - Assisted cooking by food selection



**CookingPlanner** - Assistant for planned cooking



**Regenerate** - Assistant for regeneration of cooked foods



**MyCare** - Self-cleaning programs



**Recipes** - Access to the user's and Mychef's recipe books



**Settings** - Access to oven settings

#### 7.1.4. Mychef iBAKE main functions

##### - **Chef**

The Chef cooking mode allows cooking by manual parameter adjustment:

- Convection
- Mixed
- Steam

By setting additional functions to the cooking modes, it is possible:

- Cooking with/without probe
- Cooking  $\Delta T$
- Night cooking
- Programming cooking cycles and adding standby cooking.
- Adding intermediate steps to a cooking and receiving notifications.
- Save cooking settings in the recipe book hosted in the Cloud.



## - **SmartCooking**

The SmartCooking cooking mode assists the cooking in an easy and intuitive way. By quickly selecting foods classified by category, it enables intelligent cooking using predefined parameters that are adapted to the type of preparation of each food.

This cooking mode allows you to obtain cooking with constant results.

Each food category has the Cook&Go option, a quick and direct access to settings of cooking parameters.

## - **Regenerate**

This mode allows access to two regeneration functions:

- Chef: Allows you to set regeneration parameters manually.
- SmartCooking: Regeneration by fast selection of foods and adjustment of predefined parameters to ensure correct regeneration.

## - **MyCare**

MyCare allows cleaning the chamber by selecting one of the different self-cleaning programs available.

- Rinse
- Eco
- Short
- Medium
- Long

## - **Recipes**

There are three different options available for managing recipes in the Mychef ovens:

- Recipes: This recipe book offers recipes prepared by Mychef, guided step by step and with suggestions for optimum results.
- My Recipes: With this recipe book you can create your own recipes in a simple and intuitive way, from your Mychef oven or from the mobile phone or tablet application "Mychef Cloud". Up to 400 different recipes can be cooked and managed.
- By Ingredients: The search for recipes by ingredients will allow you to make the most of the resources available in your kitchen. This mode suggests possible recipes that can be cooked after selecting one or more ingredients.

- **Settings**

In this menu, all settings of the Mychef oven can be set.

- **Help**

The "i" icon in the heading gives access to the help screen, it is present on all screens. Provides a full description of the current screen and user interface usage.

- **Fast Menu**

This option gives access to a customized menu according to the needs of each user, allowing you to improve the user experience by facilitating access to those functions that you use frequently. It will be possible to add the most frequently used functions or configure a custom menu. Using this menu restricts the use of the main menu and its functions.

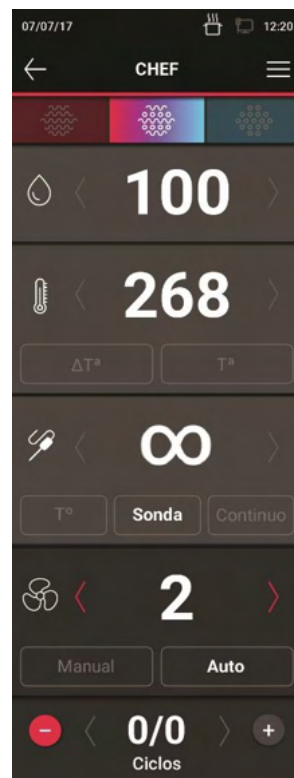
### **7.1.5. Navigation**

You can access any function of the oven by navigating from the main menu, clicking on any of its options.

## 7.2. Chef

The "manual" setting of the CHEF cooking mode parameters allows cooking with the following profiles:

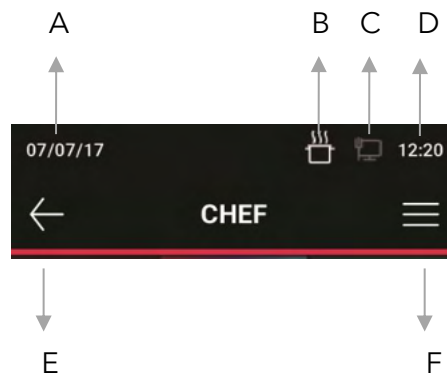
- Convection
- Mixed
- Steam
- Smoking mode (available with the use of the MySmoker accessory)



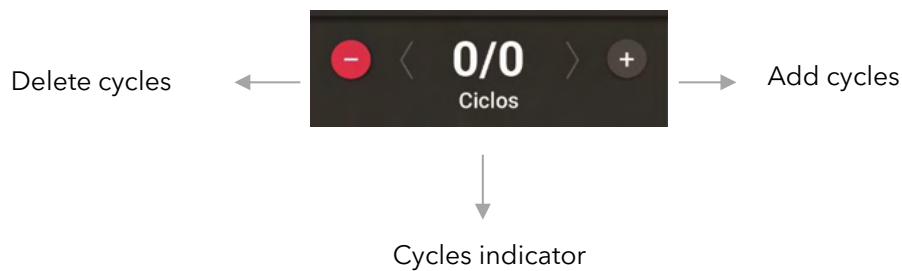
**Figure 6. CHEF screen mode**

After selecting and adjusting one of the profiles, it is possible to combine several cooking profiles by adding one or more cycles up to a maximum of 9. It will be possible to save the settings made in the recipe booklet "My Recipes" for future use. It is also possible to add a description of the steps required for cooking. By using the "Mychef Cloud" application or the USB, it will be possible to add images of the procedure and suggestions for plating.

Header functions:

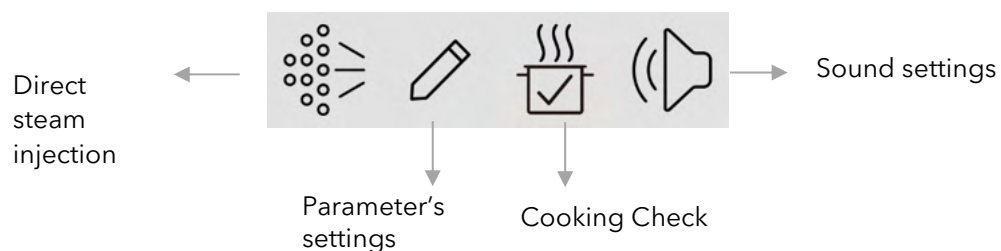


- A Current date
- B Cooking indicator
- C Wi-Fi/Ethernet connection indicator
- D Current hour
- E Get back. To return to the previous screen
- F Dropdown menu



### 7.2.1. Cooking options

During the course of a cooking in progress, it is possible to perform the following actions:



Direct steam injection allows the user to increase the humidity of the chamber at specific moments during cooking. The duration of the injection is related to the time this button is pressed.

During cooking, it will also be possible to change the parameter settings. By selecting this option, the display will show again the cooking parameters and the user will be able to refine the recipe according to his needs. To continue press the circular button START/STOP.

For precise control of the cooking, the oven has the "Cook Check" option. This option shows the corresponding values for time, temperature, energy, and water consumption.

To adjust the volume of the audible signals, press the Sound settings icon and select loud, medium or disable audible signal.

The cooking profiles allow the following cooking processes to be carried out:

**Convection** (30°C-280°C)

- Roasting
- Baking
- Grill
- Fry
- Griddle
- Smoked

**Mixed** (30°C-280°C)

- Roasting
- Gratin
- Braising
- Sauté
- Fogging
- Proofing

**Steam** (30°C-130°C)

- Steam cooking
- Sous-Vide
- Boiling

Additional functions:

**Convection**

- 4 Fan speeds
- DryOut

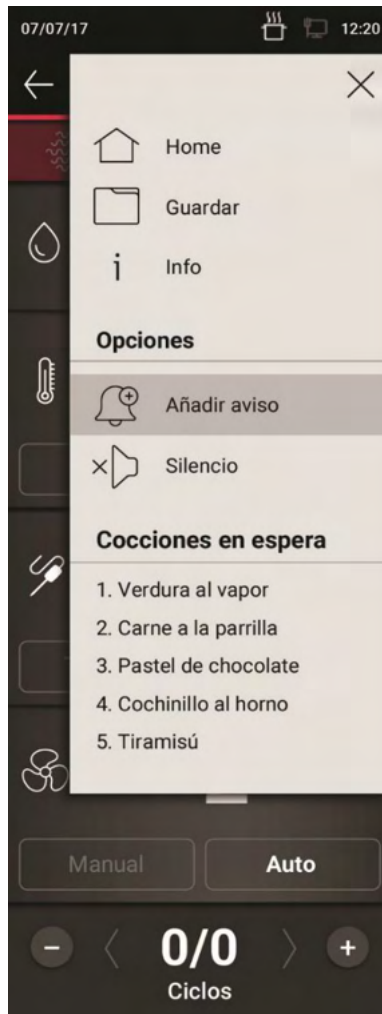
**Mixed**

- 4 Fan speeds
- SmartClima

**Steam**

- 4 Fan speeds

In each cooking cycle it is possible to add a warning at a specific time. This way, it is possible to have a more exhaustive control of the cooking process by carrying out the necessary actions to improve the result. During cooking, an on-screen notification and on the mobile device will prompt the operator to take action. For example, add a broth after 15 minutes from the start of cooking.

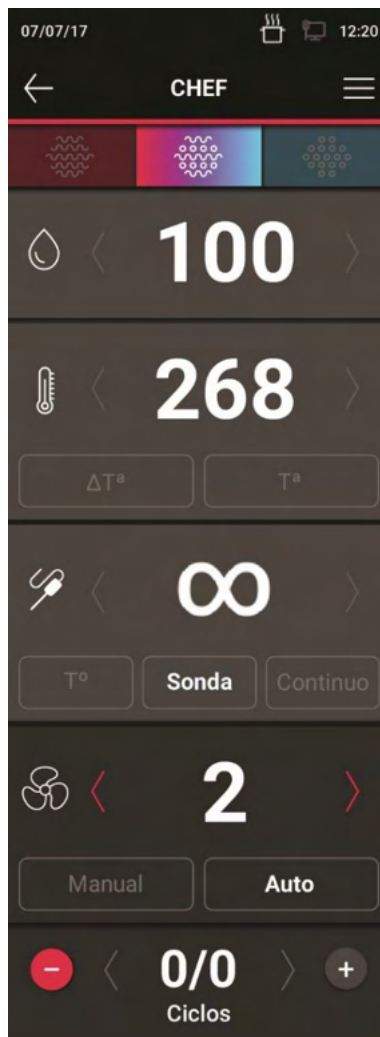


**Figure 7. Set up to add notification message**

When you press add alert, you are prompted to enter a text message and select the time when the message will be displayed. When the cooking starts and the indicated time has elapsed, the message will notify.

### **7.2.2. Chef Menu**

There are 400 programs that can be edited and retrieved at the user's request. All of them can have up to 9 cooking cycles. To start a cooking, it is necessary to define at least one cycle.



**Figure 8. Chef mode screen**

In user programs, it is possible to change any cooking parameters (temperature, humidity, time, cooking mode, etc.). To do this, you must select the button corresponding to the parameter to be modified and adjust the parameter value.

There are several safety measures that prevent abnormal operation of the equipment, of which the user must be aware during use.

In case of any error, the unit will stop and display the error code (see chapter 7.8.17).

The oven will not operate if the door is open.

## Cooking modes:








There are three cooking modes: convection, mixed and steam. To select a particular mode, click on the corresponding button.



The convection mode acts as a forced convection oven without adding or removing moisture from the cooking chamber.

The combi mode allows intelligent and controlled regulation of the removal or supply of moisture in the cooking chamber. To do this, press the humidity button and set the desired value.

The steam mode saturates the cooking chamber with moisture.

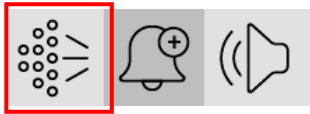
			
 Humidity	0%	-100 % <-> 100 %	100%
 Temperature	$\Delta T$ $T^a$		
 Time	$T^o$ Probe Continuous		
 Fan	Auto Manual		



***In order to prolong the life of your oven, it may automatically reduce the maximum cooking chamber temperature.***



In all cooking modes it is possible to humidify the chamber at will, through the direct injection of steam through the drop-down menu, in options:



### 7.2.2.1. Temperature cooking and time control

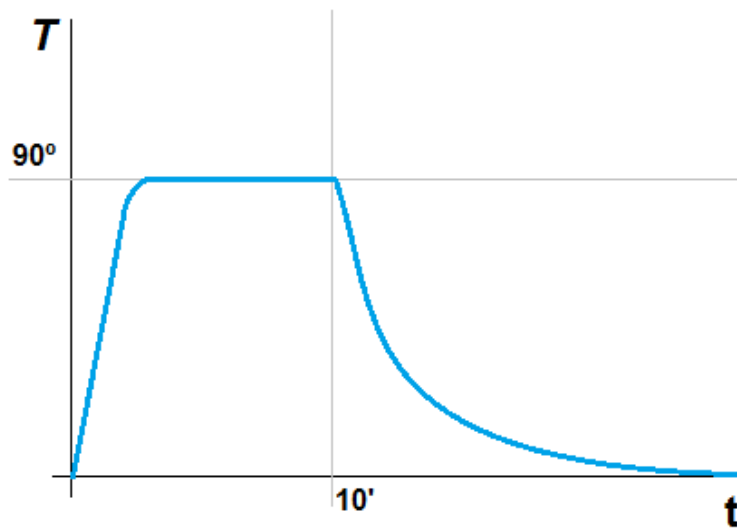
The temperature and time control mode is the simplest, we simply choose a temperature and time by pressing the display after pressing the TEMPERATURE and TIME buttons respectively.

When the circular button START/STOP is pressed, the oven will start heating the chamber and stop after the set time has elapsed.

Example of cooking at 90°C for 10 min:



Figure 9. Example. Cooking 90°C in steam mode for 10 minutes



**Figure 10. Oven temperature**

### **Automatic temperature adjustment**

Whenever cooking is started by pressing the circular button START/STOP, the oven automatically calculates the room temperature in the chamber and decides whether a heating or cooling process should be carried out depending on the desired value.

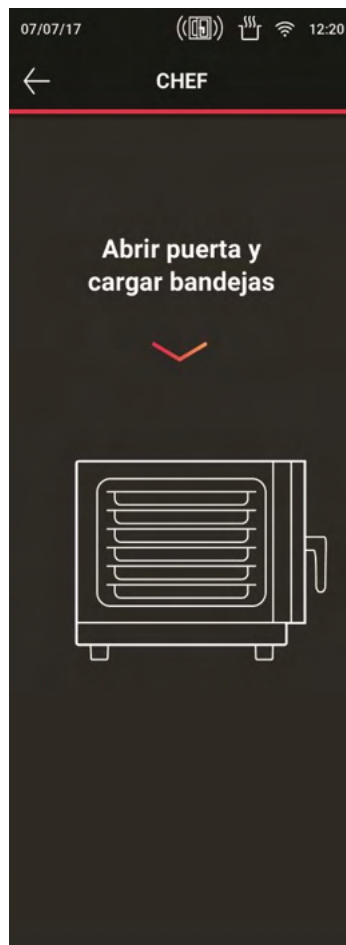


**Figure 11. Temperature settings screen**

If necessary, the following display for the temperature adjustment process will be displayed before cooking begins, indicating the chamber temperature.

If the user wishes, he or she can interrupt this process and start directly with cooking. Pressing the circular button START/STOP button omits preheating and starts cooking.

Once the oven reaches the preheating temperature, the user will be told that the oven can be charged by means of an acoustic and visual warning: an animation will be shown on the screen as in the picture.



**Figure 12. Open door and load trays warning**

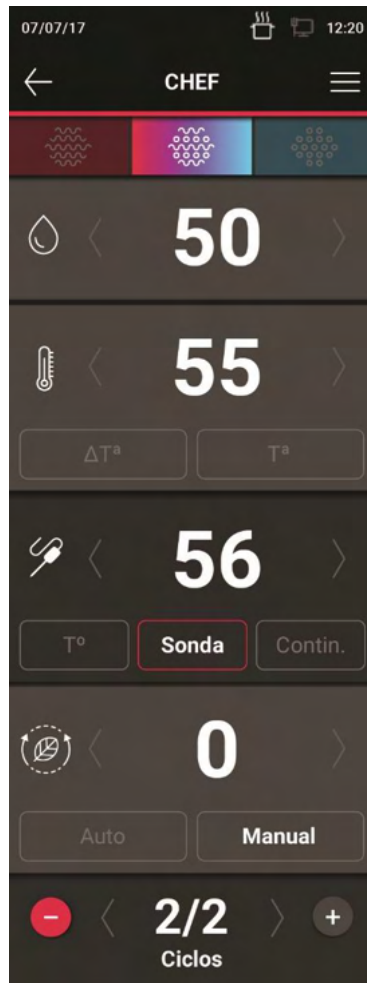
When you open the door and load the oven, cooking starts automatically.

To avoid excessive overheating, this state is maintained for a maximum of ten minutes.

### **Temperature cooking and core probe**

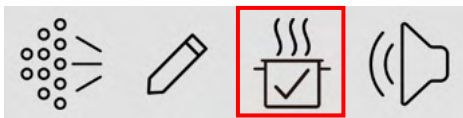
The core probe-controlled temperature control mode ends cooking when the temperature in the food core is equal to the selected temperature. The chamber temperature is kept constant and equal to the selected temperature value.

To use this mode, we choose a chamber temperature and a desired temperature at the heart of the food by pressing the TEMPERATURE and PROBE buttons respectively and adjusting them. Pressing the circular button START/STOP button will start the oven to warm up and stop when the core probe temperature is equal to the probe set point temperature.

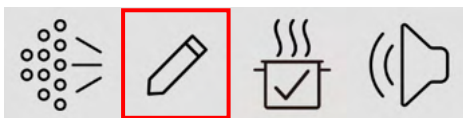


**Figure 13. Temperature configuration and control by core probe**

If we are performing a core probe-controlled cooking cycle, the time/probe display will indicate the actual probe temperature. By pressing the cooking options button, we can control the temperature of the probe through the "Cooking Check" option:



If you wish to adjust any of the cooking parameters, press:





**Figure 14. Cooking parameters settings**



***When the oven is in the process of cooking controlled by the core probe, the chamber temperature display shows the temperature to be reached in the chamber, and the core probe display shows the actual temperature of the food.***

### **Fan speed selection**

In any cooking mode, the user can select the fan speed that best suits his needs. To do this, press the fan speed parameter where it will be possible to select from several options:

Auto mode: The fan speed will be adjusted automatically according to the type of cooking being carried out, optimizing the cooking result.

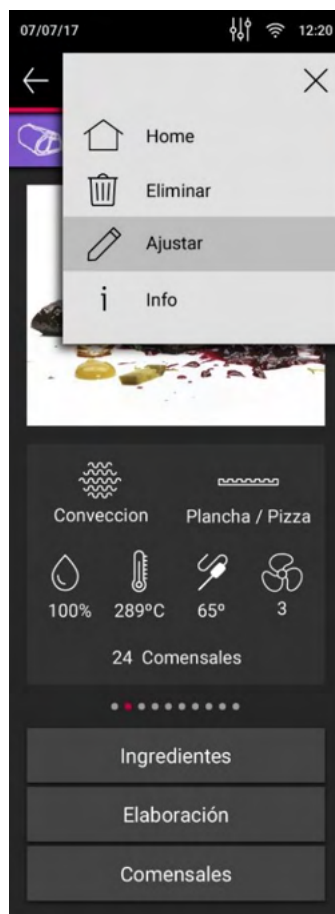
Manual Mode: This mode allows you to select the fan speed from a range of 4 speeds.



***In order to be able to regulate the temperature in the chamber correctly, in certain situations (low temperature, etc.) the oven can automatically select the reduced convection speed.***

### 7.2.2.2. Editing cycles

The editing of the cycles can be done directly by navigating through the cycle indicator or you can add phases to the user programs. You can also change a cooking cycle via "My Recipes" in a previously saved cooking cycle.



**Figure 15. Cycles edition**

Accessing through the edit option of the drop-down menu, you can access the editing of the parameters.

Through the App it will be possible to edit the rest of the recipe fields, including the preparation, photos, etc.



***To add or remove phases in programs 1 to 400 before you must enter the program edit mode.***

### **Navigate between different cycles**

navigate between the different cycles, click on the arrows of the cycle indicator <1/2>.



***The first number in the cycle indicator indicates the current cycle and the second number indicates the total of existing cycles.***

### **Add a cycle**

To add a cycle to a cooking, press the (+) button. The mode must then be selected, and the cooking parameters set.

Once a cycle has been added, the cooking parameters of the cycle can be modified, just select the cycle you want to modify and adjust the parameters.

### **Delete a cycle**

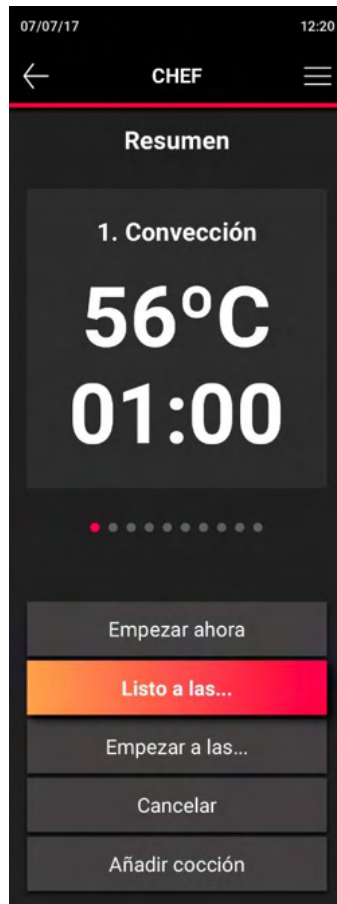
Press the (-) button to delete a cooking cycle.

### **7.2.2.3. Initiate cooking**

Once the cooking parameters have been selected, either manually or in a specific program, we can start the process.

To do this, press the circular button START/STOP key, and the following screen will appear:





**Figure 16. Screen of summary cooking cycles**

This screen shows a summary of the programmed cooking cycles and allows you to view and navigate between them to see the parameters in detail. Each time a cycle ends or automatically moves to the next cycle, an acoustic signal is emitted.

If cooking is to be started, selecting "Start now" will start cooking, the LED will illuminate and the cooking indicator in the header will activate.

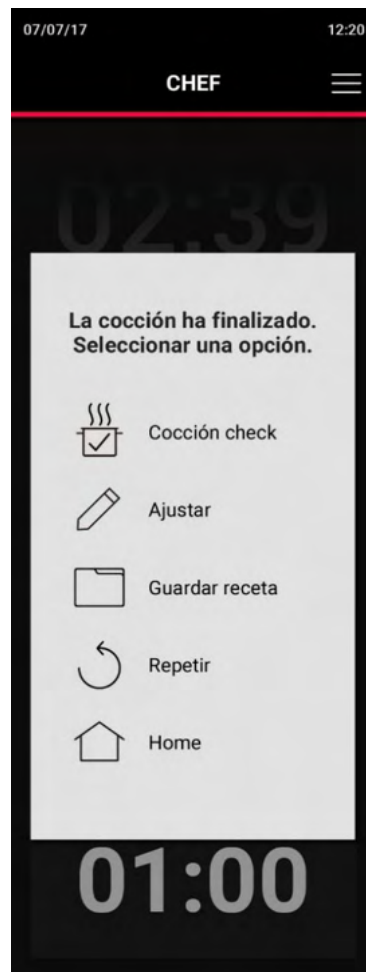
If you want to program the start, i.e. set a time later than the current one for its start, you can program it in two modes. First, with the "Ready to cook..." option, you can set a time of one hour after cooking has finished, so that the oven automatically calculates the end of cooking according to the cooking time. With the "Start at..." option, you can program the start of cooking at any given time.

This screen also allows you to cancel the cooking and add a standby cooking. In the latter case, the cooking will remain in standby, and a new cooking can be configured. Once the programming of the next program has been completed, the cooking can be started.

#### 7.2.2.4. End of cooking

A cooking ends when time is up or the temperature at the heart of the food is reached. At the end of a cooking cycle, the equipment indicates this state visually and acoustically. Specifically:

- An acoustic signal is emitted.
- The end of cooking message is displayed.



**Figure 17. Cooking finished message**

Once the cooking message is finished, you must choose one of the options shown.

**Cooking check:** Display of resources used during cooking, temperature, time, water and energy.

**Adjust:** Sometimes it is necessary to add time to a cooking. This option allows you to fine-tune the result by adjusting the time.

**Save recipe:** With this option, it will be possible to save the parameters in the recipe book by creating a recipe and reuse it in the future. Parameter settings do not need to be reset. It is possible to save a recipe before or after cooking.

**Repeat:** Run the same cooking program again.

**Home:** Return to the Home screen.

You can also exit the displayed screen by pressing the circular button START/STOP.

You can also interrupt the cooking process at any time by pressing the circular button START/STOP to stop cooking.

### 7.3. SmartCooking

After selecting the SmartCooking cooking mode in the main menu, you access the following screen where a series of foods are displayed. This mode allows you to select the food by category and choose from the preparation procedures that each food allows.

For example: Meat → Beef → Sirloin → Grill set cooking parameters → circular button START/STOP.

The same happens with the SmartBaking mode, with this mode is possible to select between different types of pastry preparations.

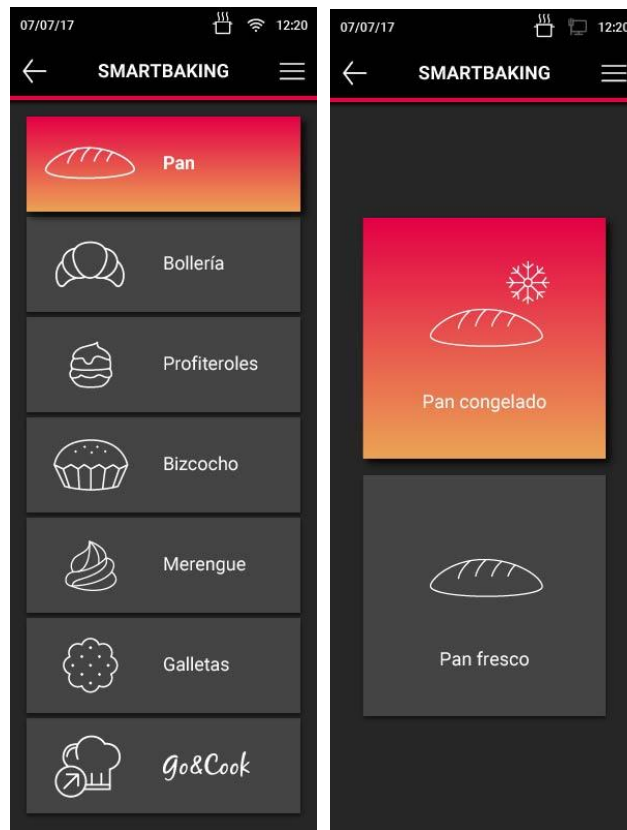
For example: Pastry → Frozen Pastry → Bake → Set cooking parameters → START/STOP circular button

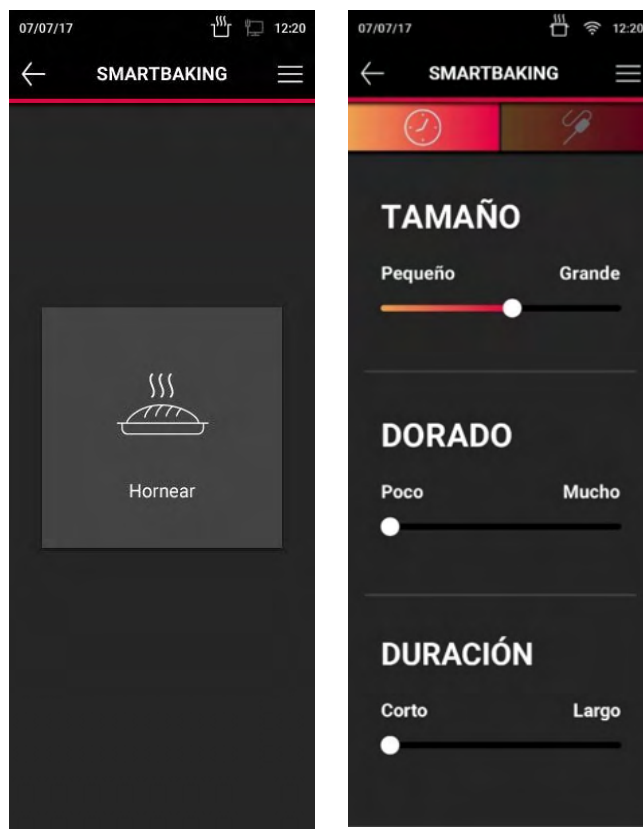


**Figure 18. SmartCooking screen**

### 7.3.1. SmartBaking mode

The SmartBaking mode makes available certain cooking profiles, where it will be possible to select and modify the cooking parameters, starting the cooking immediately to obtain an optimal result.





**Figure 19. Example of SmartBaking mode parameter selection**

Some foods allow probe cooking, this option can be selected when compatible. It will be possible to carry out cooking by probe and sous vide.

The sous vide or low temperature cooking is especially suitable for meats, poultry or fish and some vegetable preparations. This cooking allows the food to be cooked more gently, lose less juice and preserve its qualities.

It is possible to stop the cooking at any time by pressing the circular button START/STOP.

The drop-down menu in SMARTCOOKING and SMARTBAKING shows the following options:

1. Home
2. Cooking aid: This option will display tips and advice to optimize cooking results.
3. Display information and help

To start cooking, once all parameters have been set, press the circular button START/STOP. A summary of the selected cooking is shown below.

If cooking is to be started, selecting "Start now" will start cooking, the LED will illuminate and the cooking indicator in the header will activate.

If you want to program the start of the cooking, you can program it in two modes. First, with the option "Ready at..." you can set the time when the cooking needs to be ready. With the "Start at..." option, you can program the start of cooking.

This screen also allows you to cancel the cooking and also add a standby cooking. In the latter case, the cooking will remain in standby, and a new cooking can be configured. Once the program of the next program has been completed, the cooking can be started.

It is also possible to save the recipe with the settings selected in the recipe book "My Recipes", so that the user can create his or her own profile of assisted cooking and have a faster access in future occasions from the recipe book.

### 7.3.1.1. Go & Cook

The Go&Cook cooking mode is a direct cooking method, suitable for each food category. Once the category has been selected, for example: "Meat", the Go&Cook option will show us directly the available preparations for meats: Fry, Grill, Griddle, Roast, Braise, Steam, Sous vide and MySmoker. When you select the preparation mode, for example: Frying, you access the cooking parameters screen. In this case it is possible to select Fry by Time or by Probe, as shown below:

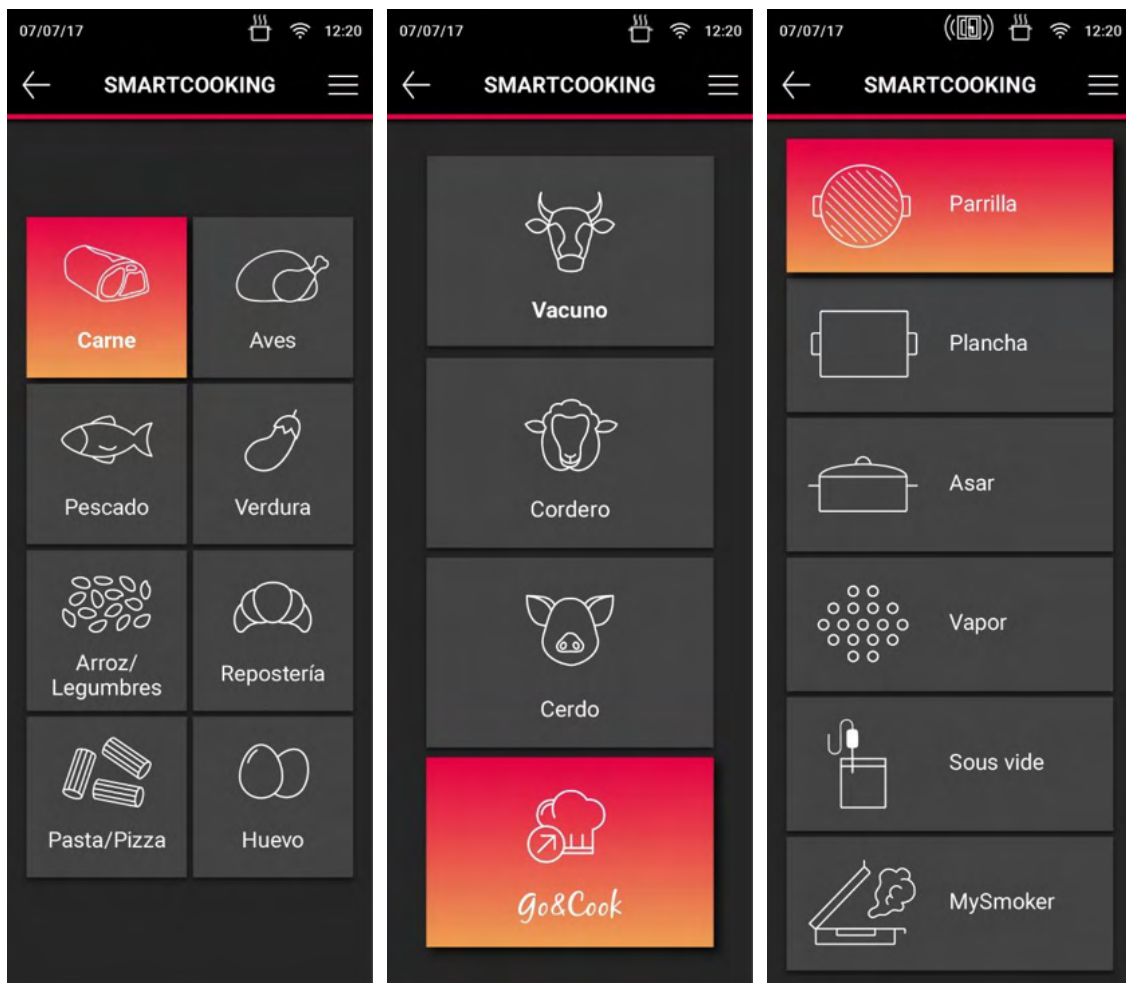


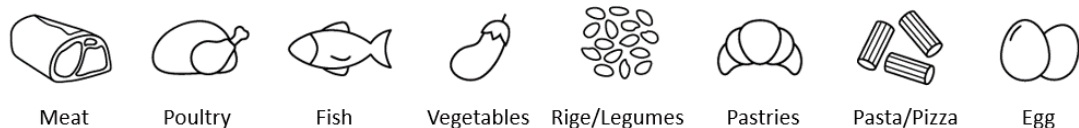
Figure 20. Example of Go&Cook mode parameter selection

### 7.3.1.2. Save a cooking configuration or create a recipe

It is considered that it is previously on the Chef screen, and the cooking parameters have been adjusted or a recipe has been created from the "Mychef Cloud" application.

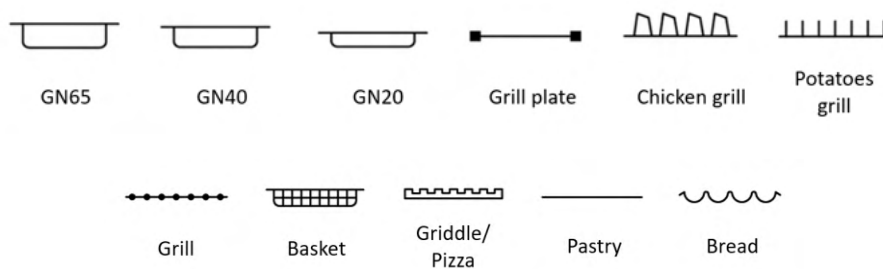
After selecting the Save button, the following screen appears where you must enter the necessary data to correctly describe the recipe you want to save.

Category: Establishing a category will allow a better management of recipes, the categories are as follows:



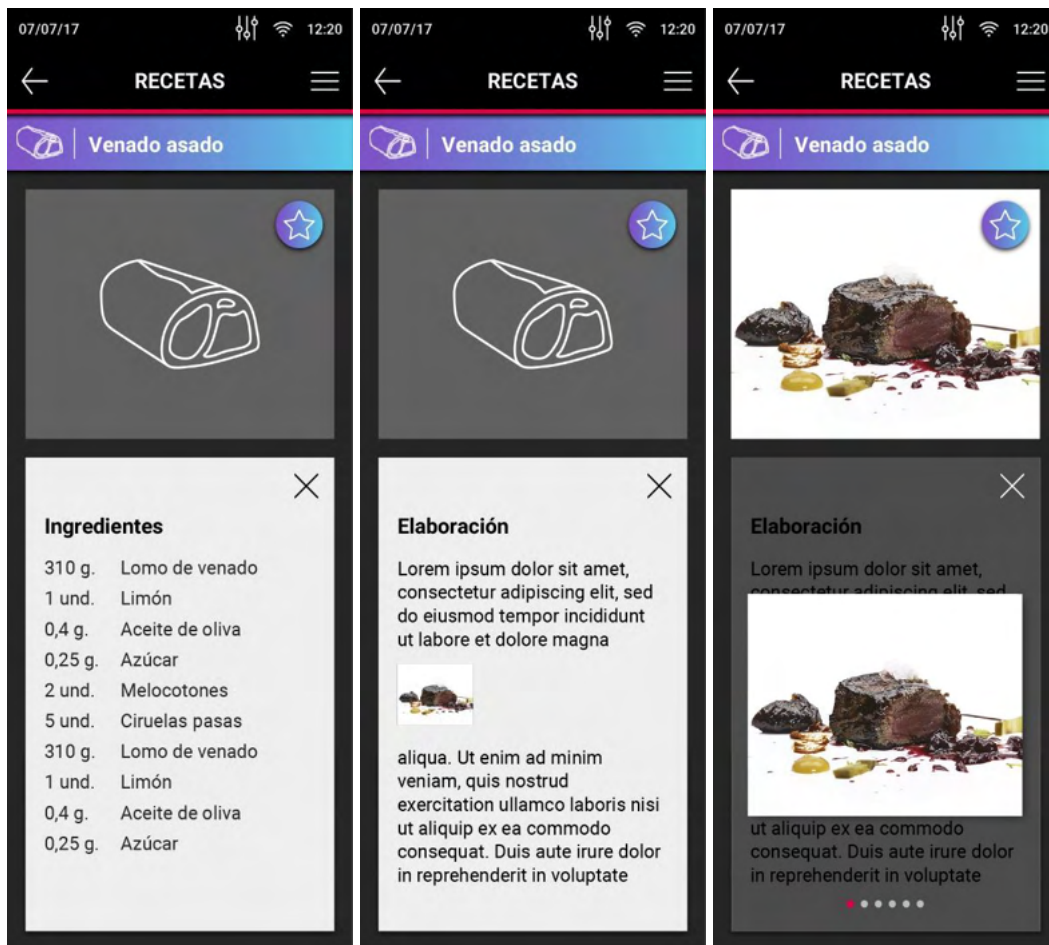
After selecting a category and entering a name with which to save the recipe.

To complete the recipe edition, it will be necessary to access the "Mychef Cloud" application. It is possible to edit the recipe and choose the type of tray that is recommended for cooking:



Then select the ingredients field, where a new window will open in which you can enter the ingredients that make up the recipe.

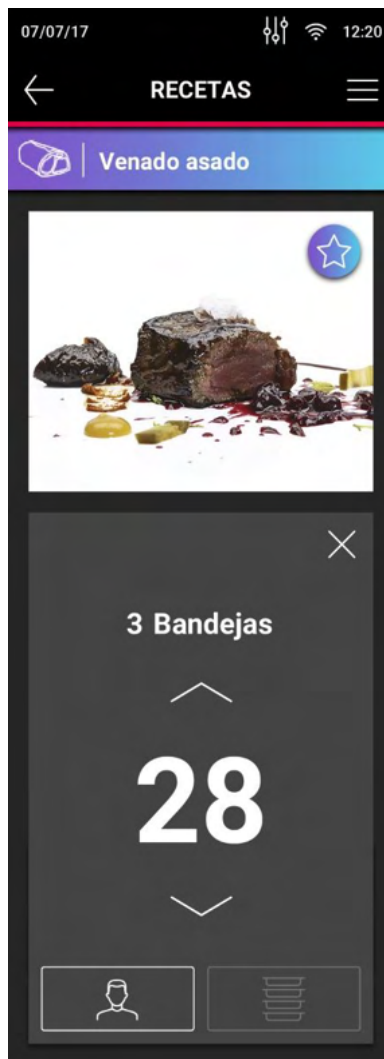
Next, it is asked to add the different steps that make up the preparation of the recipe. At each step it will be possible to upload an image to illustrate the preparation procedure. In the same way, it will be possible to add plating suggestions in the final step and add an image.



**Figure 21. Recipe's screen**

It is possible to adjust the number of diners or trays to know exactly the quantities of ingredients to be used in each case. By means of the parametric calculation, the ingredients section will show the new quantities required for the preparation of the recipe.





**Figure 22. Adjust the number of dinners or trays**

#### **7.4. CookingPlanner**

CookingPlanner mode allows you to cook several trays of the same food or different foods or recipes that require different cooking times in different levels.

For simultaneous cooking, only preparations with similar cooking profiles can be selected from Chef, SmartCooking or Recipes mode, which are the same in terms of temperature and humidity. Therefore, it will be possible to combine a cooking in this cooking mode when the parameters are similar and only the cooking time varies. In order to load SmartCooking cooking procedures in the CookingPlanner mode, it will be necessary to save them in the recipe book with the desired parameters. A clock icon at the top left will indicate that the recipe is compatible with CookingPlanner mode. These cooking do not allow cooking cycles.

To load a CookingPlanner, select Multilevel or JustInTime and press the (+) button at the desired level, then access the recipe book where the recipes compatible with this cooking mode appear. Then select a first recipe and click "Add to Multilevel" or "Add to JustInTime".

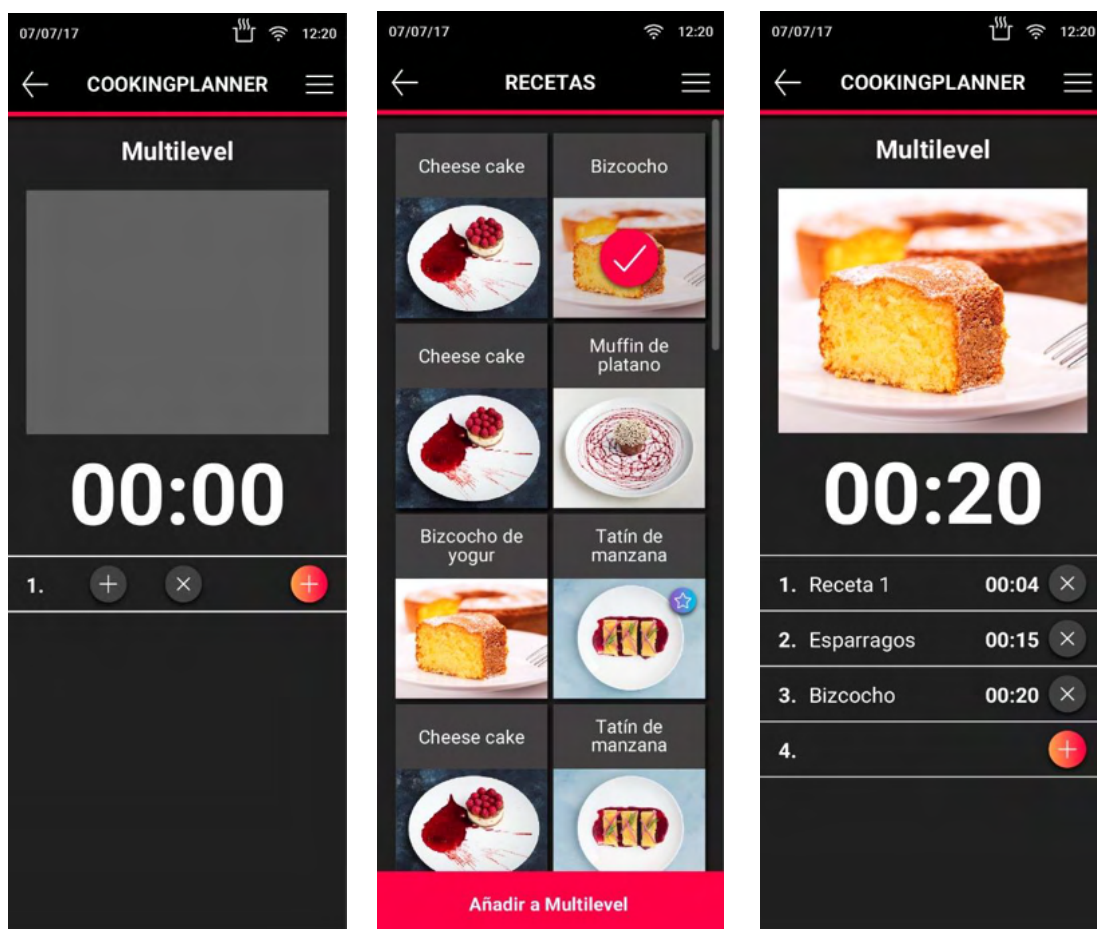


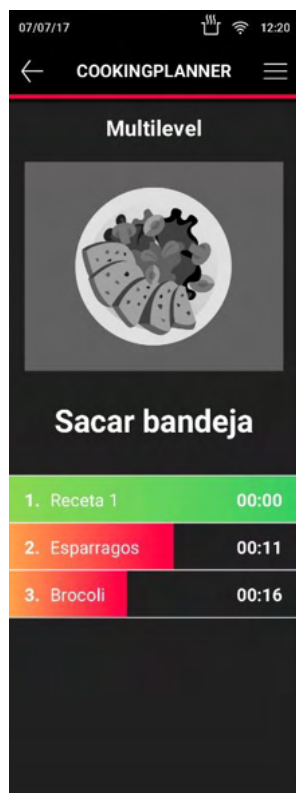
Figure 23. CookingPlanner screens



***The recipe names are given as an example.***

The CookingPlanner mode has two different profiles from which you can choose:

- Multilevel: for cooking that starts at the same time, under a single cooking cycle and different finishing times depending on the recipe of each tray. The system will notify the user via the display and on the mobile device via a notification when each tray must be removed at the end of cooking. Additional products can be loaded, cooking stops when the door is opened. When the door closes, the process will resume.



**Figure 24. Multilevel option**

- JustInTime: for recipes that we want to be ready at the same time, notifying you when to load the trays at different times. In this case, the system will notify when trays need to be introduced based on cooking time to allow all food to be cooked at a particular time. This baking mode maintains the set temperature and humidity.



**Figure 25. JustInTime option**

Any cooking process can be interrupted without interfering with the other loads.

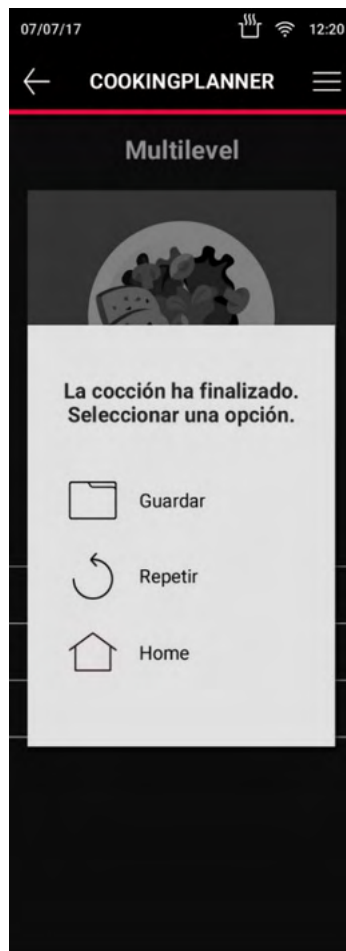
At the end of a cooking process, both in Multilevel and JustInTime, the screen will show in green which of the trays is to be extracted, in order to continue cooking. Performing the action of opening the door, pulling out the tray and closing the door.

Probe cooking is permitted only on one of the trays. In this case, the cooking of this tray will end when the temperature set for the probe is reached.

To display the total number of trays, it is possible to slide by pressing on the screen.

#### **7.4.1. Save CookingPlanner**

You can save a list of recipes in Multilevel or JustInTime under "My Recipes", either after loading all the recipes you want to cook, through the save option in the header, or once the process is finished, as shown below:



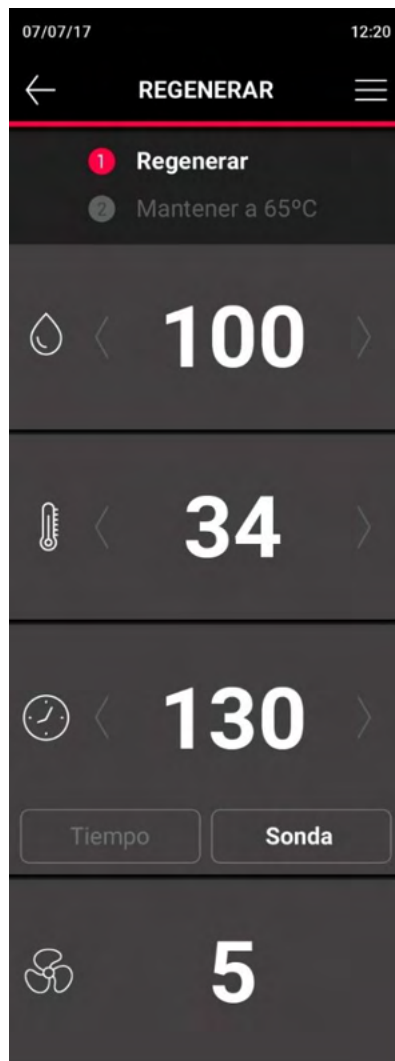
**Figure 26. Save recipes list after cooking is finished**

## 7.5. Regenerate

The regenerating mode allows the regeneration of almost all types of previously cooked foods, where they are finished cooking and prepared to be served, for this purpose the foods can be already arranged in plates or containers. You can select to regenerate manually with the "Chef Mode" or assisted "SmartCooking Mode".

- Chef Mode: To start this mode it is necessary to adjust the Humidity, Temperature and Time parameters and press the circular button START/STOP. The fan speed will be adjusted automatically. Once regeneration is complete, a maintenance cycle starts at 65°C, which will end only when the circular button START/STOP is pressed.

Note: For temperature settings below 160°C the use of probe is recommended.



**Figure 27. Regenerate mode Chef**

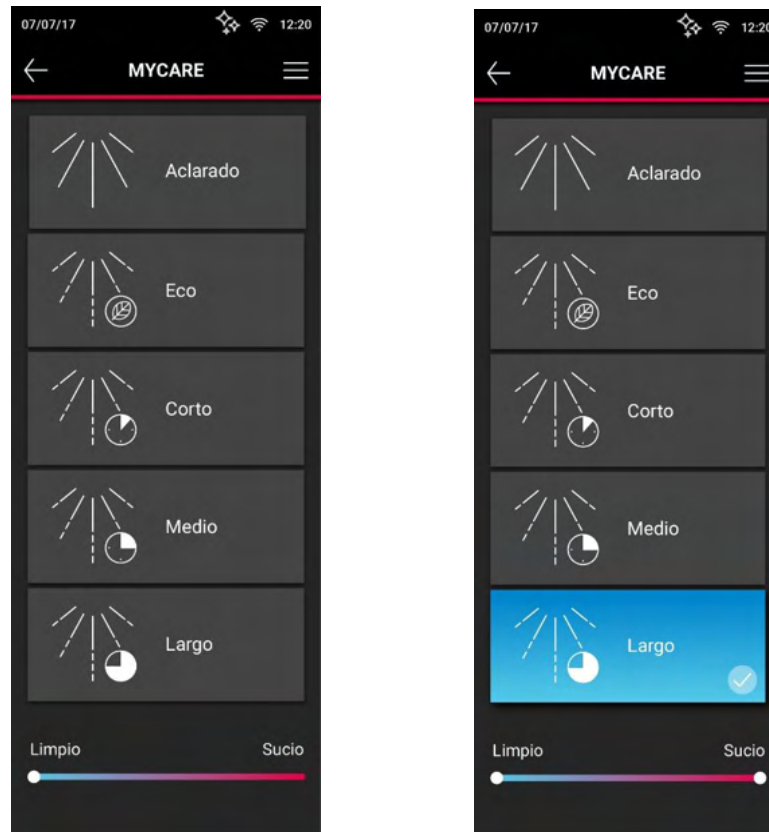
- SmartCooking Mode: This regeneration mode allows you to regenerate food by category, with assistance. Simply select the type of feed and adjust the parameters shown in the following screen and press the circular button START/STOP.



**Figure 28. Regenerate mode SmartCooking**

## 7.6. MyCare

Using the Mychef cleaning system allows automatic cleaning of the cooking chamber. This option includes several self-cleaning profiles available, as shown below:



**Figure 29. MyCare self-cleaning programs**

- Rinse: Program of rinsing the chamber with water.
- Eco Wash: This program allows an efficient washing with optimization of resources.
- Short Wash: Short duration washing program.
- Medium Wash: Medium duration washing program.
- Long Wash: Long-term washing program.

The lower bar "Clean-Dirty" shows the level of dirt in the chamber and based on this, the suggested self-cleaning program is indicated.



The time required to carry out each program and the use and usefulness of each program are listed in the table below.

<b>Program</b>	<b>Description</b>	<b>Duration</b>
<b>Eco</b>	ECO self-cleaning program	63 min
<b>Short</b>	Self-cleaning program for low dirt level	103 min
<b>Medium</b>	Self-cleaning program for medium dirt level	143 min
<b>Large</b>	Self-cleaning program for high dirt level	183 min
<b>Rinse</b>	Rinse program	10 min

**Table 6. Self-cleaning and rinsing programs (MK2 system)**

<b>Program</b>	<b>Description</b>	<b>Duration</b>
<b>CLEAN 1</b>	ECO self-cleaning program	45 min
<b>CLEAN 2</b>	Self-cleaning program for low dirt level	70 min
<b>CLEAN 3</b>	Self-cleaning program for medium dirt level	90 min
<b>CLEAN 4</b>	Self-cleaning program for high dirt level	110 min
<b>RINSE</b>	Rinse program	5 min

**Table 7. Self-cleaning and rinsing programs (MK3 system)**

When starting a washing program, it is necessary to know the instructions for use and warnings of danger that appear on the MyCare "CleanDuo" washing tablets.



**Figure 30. Start of washing program**

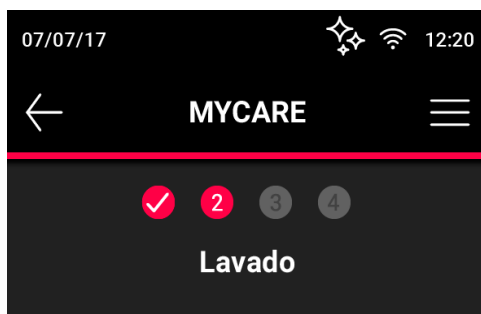
Before the self-cleaning cycle, remove any pieces of solid food that may be inside the chamber by hand. To remove food residues from the cooking chamber, remove them beforehand and prevent them from going down the drain. You should not place trays or racks during the washing process. It must always be carried out without load, to ensure that the equipment is cleaned properly.



***For the use of the washing processes in as much as for the handling of the products used in the process, appropriate protections must be used.***

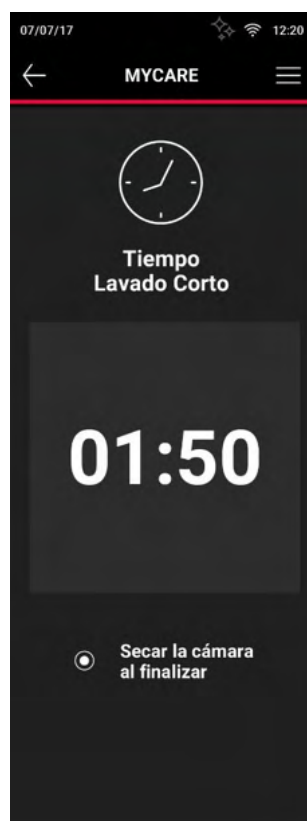
Cleaning programs are specifically designed to use MyCare CleanDuo detergent. The special formulation of this product stands out for having twice the concentration of active product than that of most similar products available on the market. It also includes a polishing additive for a perfect all-in-one finish. This allows you to use only one MyCare CleanDuo tablet per wash, with the consequent savings and ease of use.

Once the selected washing program has been started, the display will show the oven user the progress and ask him/her to perform the necessary actions to carry out the task correctly.



**Figure 31. Washing progress information**

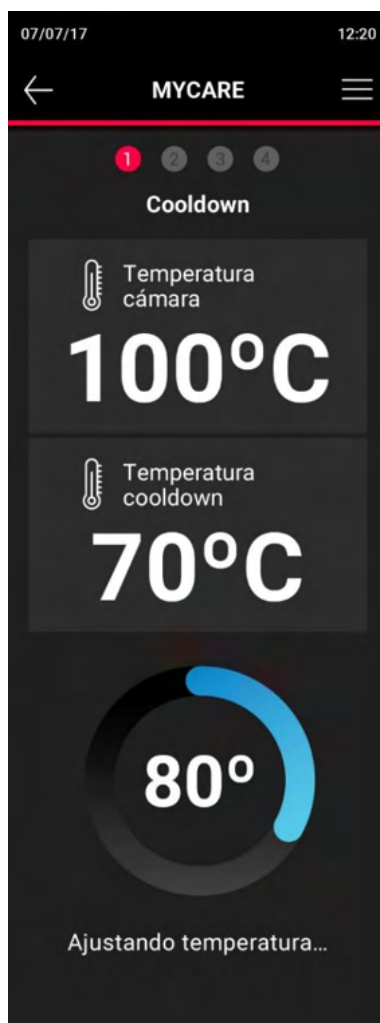
At the end of a washing program, the chamber may be dried. To do this, it is necessary to select the option "Dry at the end of the camera", at the beginning of the program, prior to selecting the circular button START/STOP.



**Figure 32. End of washing program**

Before inserting the MyCare CleanDuo tablet, check that the cooking chamber temperature is not too high. In certain cases, before the start of the washing program, it will be necessary to cool the chamber by means of the Cooldown action in order to ensure that the washing

is carried out correctly. The oven will begin a cooling process that can be done with the door open to make it faster. A direct notification will display through the following screen:



**Figure 33. Cooldown process**

Once the right temperature is reached, insert the detergent into the dedicated housing. Once entered, close the door again to start the cleaning program.



***Before starting any cleaning process, make sure that the water supply to the appliance is open.***

If cooling is not required, you can place the MyCare detergent directly in its assigned space and start the cleaning or rinsing cycle.



**Figure 34. Housing for MyCare detergent**

The 4 600x400 model, must use 1 tablet of detergent in each cleaning cycle.

The 10 600x400 and 6 600x400 models, must use 2 tablets to guarantee a correct cleaning, due to the size of the chamber is much larger.



***Before starting any cleaning process other than rinsing, make sure that the detergent tablet has been placed in the oven.***



***To insert the detergent tablet into the chamber, it is essential to stop the fan. It is important not to introduce the detergent while it is running in order to prevent the detergent from being drawn into the air stream and endangering the health of the user.***



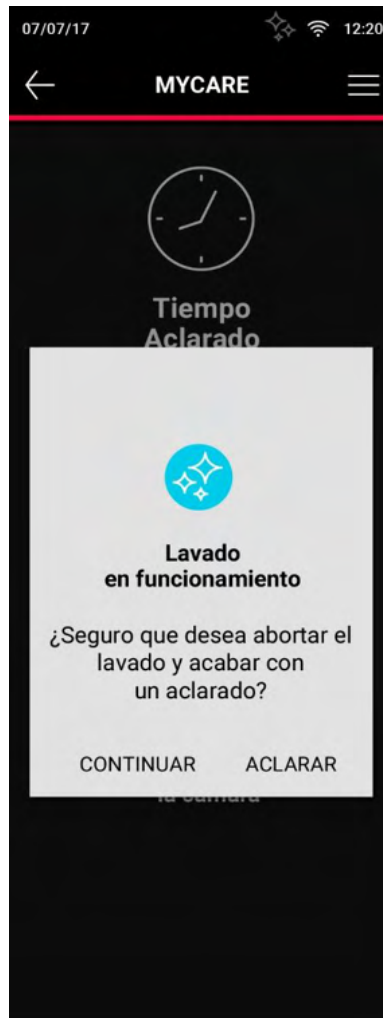
***The duration of the self-cleaning programs specified does not take into account any cooling time of the chamber.***

Once you have started the automatic process do not open the door under any circumstances, as chemicals used for cleaning and steam may escape. This situation would pose a significant risk of corrosion and burns.



***Never open the door of the cooking chamber during an automatic cleaning process.***

During the execution of a washing program, it may be necessary to interrupt it due to an emergency. In this case, pressing the circular button START/STOP will stop the program and perform a rinse to remove all detergent from the chamber.



**Figure 35. Message after pressing the circular button START/STOP**



***If the cleaning process has been stopped without the cleaning process being completed automatically, it is mandatory to remove all undissolved pieces of detergent tablet from the chamber before proceeding with the final rinse.***

If any of the automatic cleaning processes are completed and you detect that there is any detergent residue in the chamber (even behind the fan cover plate), perform a rinsing program or perform a thorough manual rinsing of the cooking chamber.

If there is a power failure during the cleaning process, an error message will be displayed on the control panel (error 26) when the oven is turned on again. In this case, and in order

to prevent detergent and brightener residue from remaining in the chamber, run a rinse program.



**Always run a self-cleaning or rinsing program when error 26 occurs.**

## 7.7. Recipes

The Mychef combi oven allows recipe management as follows:

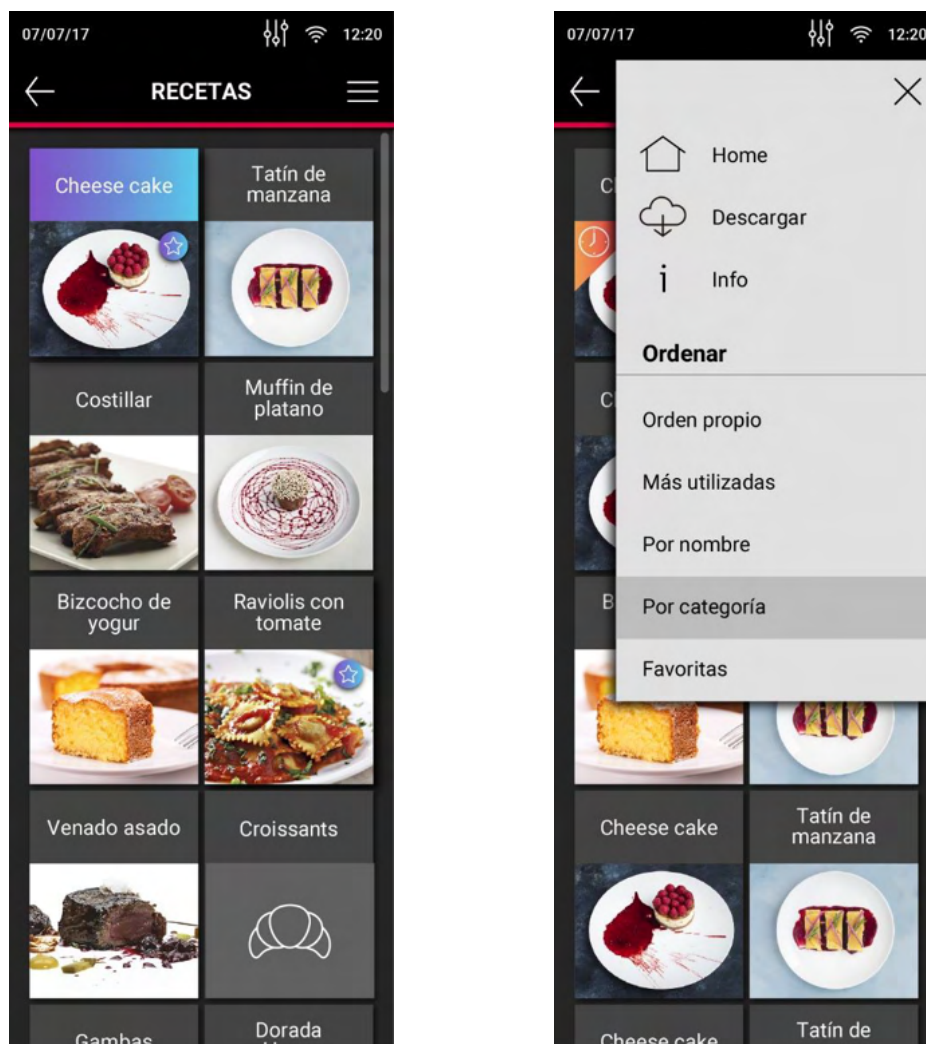
- Recipes: recipes created and managed by Mychef in which recipes are periodically uploaded through the cloud.
- My Recipes: in this recipe book you can create and change your own recipes.
- By Ingredients: the search for recipes by ingredients allows to visualize between recipes containing the selected ingredients.



**Figure 36. Recipes' menu**

### 7.7.1. Recipes

When you access this recipe book, you will be able to see all the recipes available in the Mychef Cloud. This recipe book will be updated every time new recipes are made available in the cloud, as long as the oven has an Internet connection.



**Figure 37. Recipe option**

Recipes can be sorted according to the drop-down menu below.



***The names of the recipes are given as examples.***

When you select a recipe, the recipe display corresponds to the structure shown in section 7.3.1.2.



## 7.7.2. My Recipes

This recipe book offers the possibility of displaying the recipes you have created and managing them according to your needs. The recipes listed here can be created from Chef, SmartCooking or CookingPlanner mode. When the recipe is created in SmartCooking or CookingPlanner mode, the corresponding icon will appear in the top left corner of the preview. You can download recipes from USB devices as well as save them (see section 7.8.12).

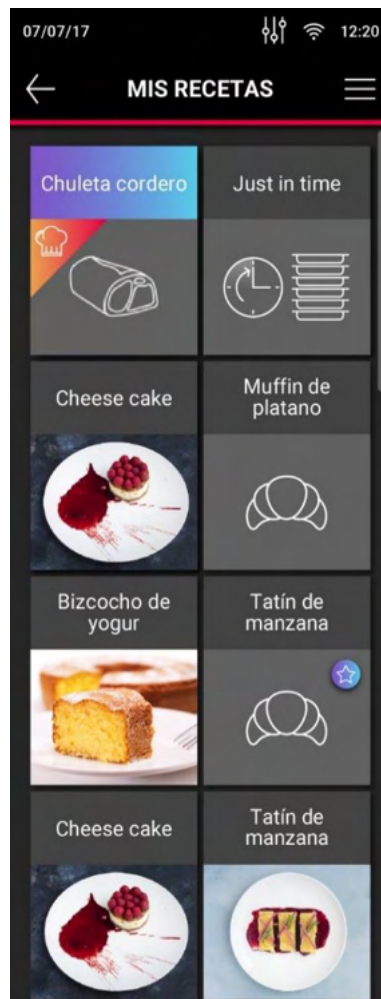


Figure 38. My Recipes main screen

### 7.7.3. By ingredients

By searching for one or more ingredients, the user interface will display the recipes available containing those ingredients, from among all the recipes available, both in Recipes and My Recipes.

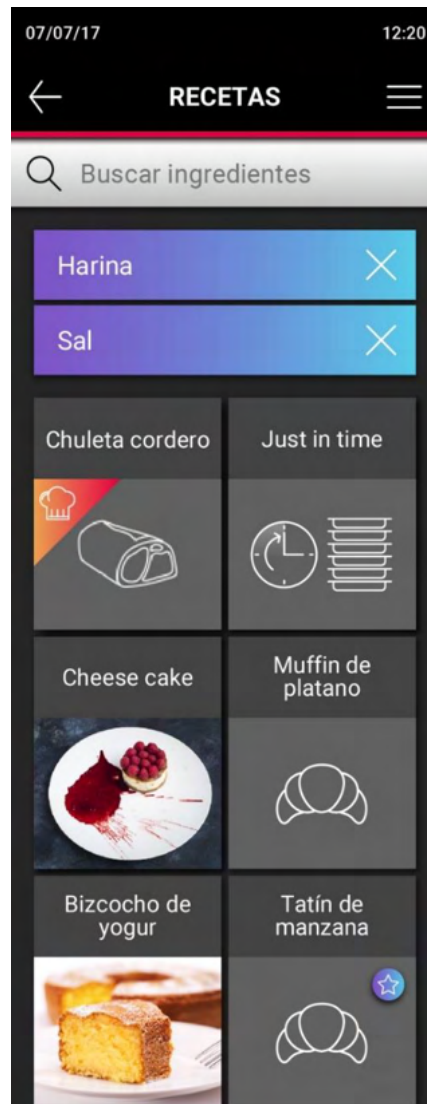


Figure 39. By ingredients main screen



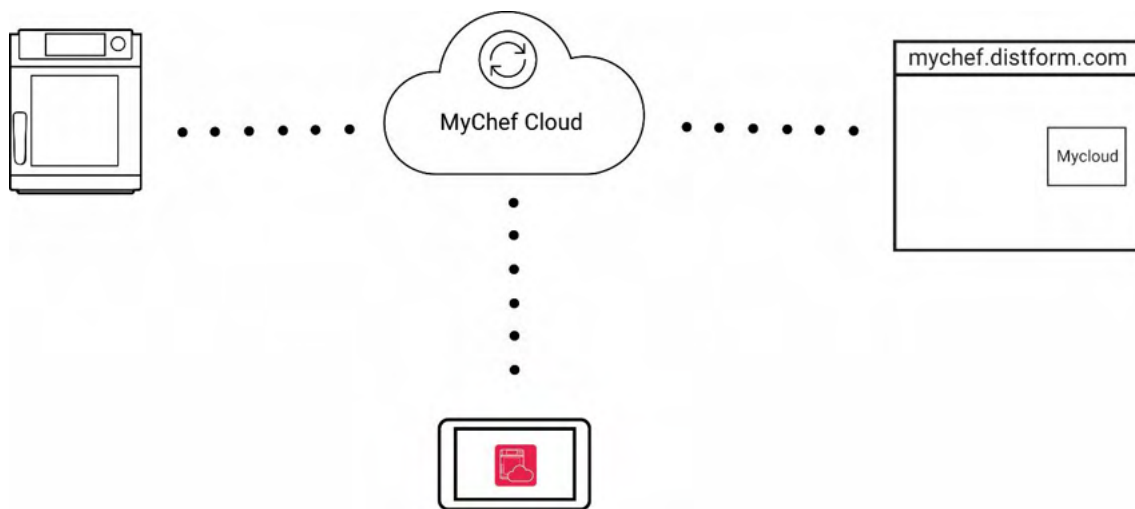
***The names of the recipes are given as examples.***

#### 7.7.4. Managing recipes from Mychef Cloud

The Mychef Cloud app allows you to manage recipes from the "Recipes" mode. The operation is similar to that of the user interface of the combi oven, as indicated in the previous sections.

The application allows the user to create recipes without having to be in the presence of the oven. Once the cooking profiles have been created, they are uploaded to the cloud where they are shared with the oven. This way it will always be possible to manage the recipes both from the application and from the oven.

It also allows the monitoring of the oven screen at all times, so that it will be possible to know what actions the oven is skinning, as well as start a cooking and know its status.



## 7.8. Settings

This section describes the operations required for the correct configuration of the Mychef combi oven. Some of the functions have access rights, so it will only be possible to access them by entering a password.

For more detailed information, refer to the help available on the screen.



**Figure 40. Settings menu**

### 7.8.1. Date/time

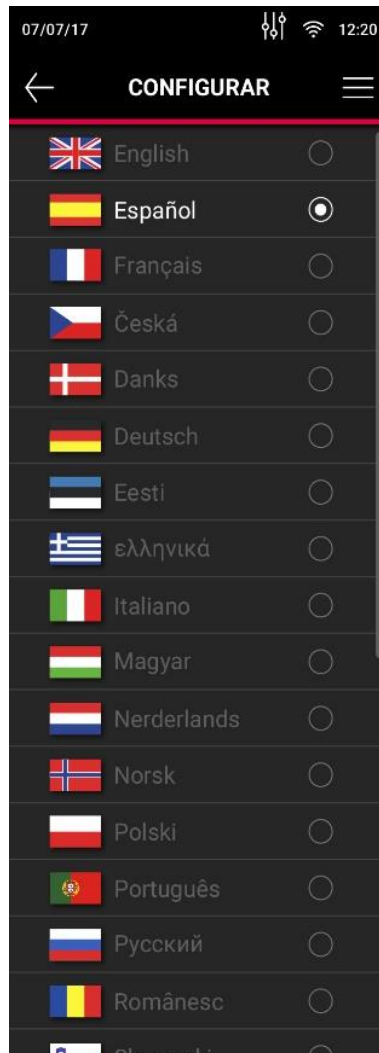
To set the date and time, press or select on the buttons and adjust. To exit, press the back arrow and the configuration will be saved.



Figure 41. Date/time settings

## 7.8.2. Language

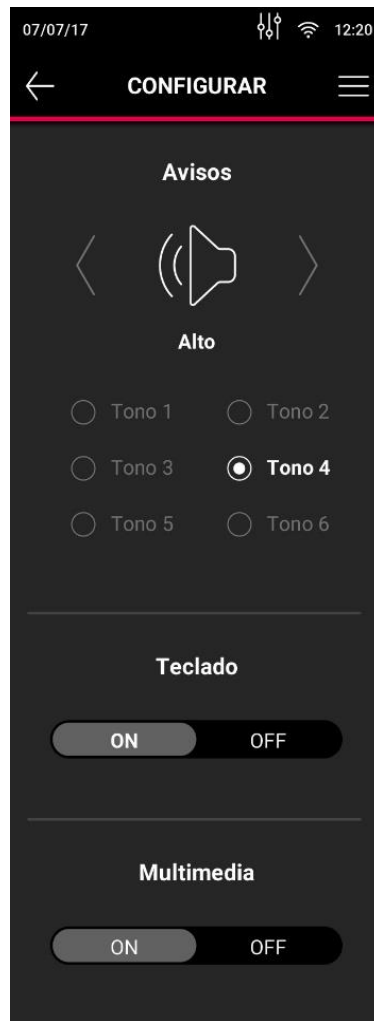
To change the language, navigate between the available languages, and select the desired language. To exit, press the back arrow and the setting will be saved.



**Figure 42. Language settings**

### 7.8.3. Volume

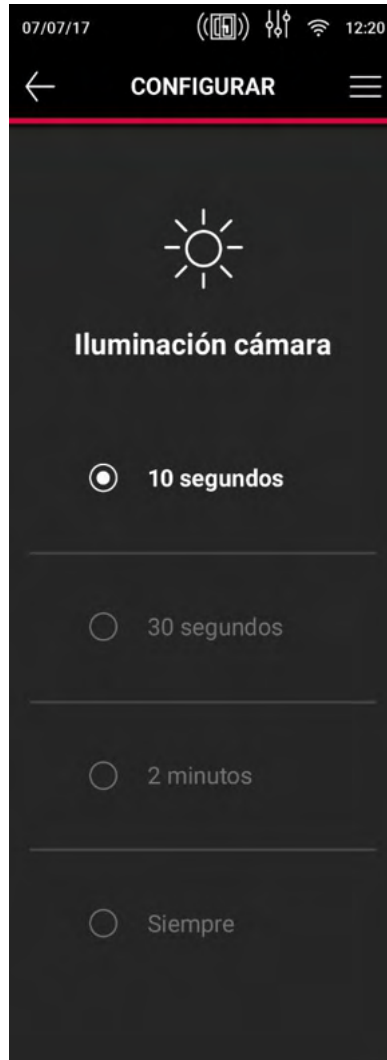
The volume setting allows you to select from three different sound options. Warning tone, corresponding to the acoustic signals emitted by the oven when performing certain functions. For example, the end of a cooking or an alarm. The volume setting also allows the sound to be muted.



**Figure 43. Sound configuration**

#### 7.8.4. Lighting

The duration of the chamber lighting can be adjusted between the options displayed on the screen. Select the desired option and press back and the configuration will be saved.

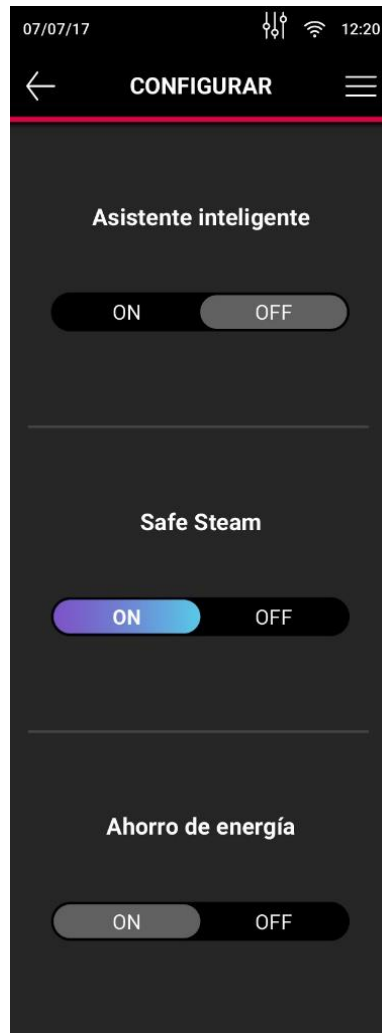


**Figure 44. Chamber light configuration**



### 7.8.5. Smart Assistant

The options in this submenu allow you to optimize the operation of your combi oven.



**Figure 45. Smart Assistant activation**

- The Smart Assistant will show usage optimization options; for example, in the configuration of the cooking processes to improve performance. You can suggest, when necessary, changes to the user settings.
- Safe Steam, if activated, removes steam from the chamber during the last moments of cooking. In order to avoid burns or steam discomfort when opening the door, Mychef ovens can remove steam from the chamber at the end of the cooking process. Even when in convection mode, this extraction can be useful to eliminate the steam that may be released from food in the cooking chamber. When the oven enters the steam extraction process, a large amount of steam can escape through the chimney, depending on the saturation level. The use of a condensing hood is recommended for Mychef ovens.



**Please note that steam extraction only works in the final moments of cooking. Therefore, this action does not occur when the oven door is opened during cooking.**

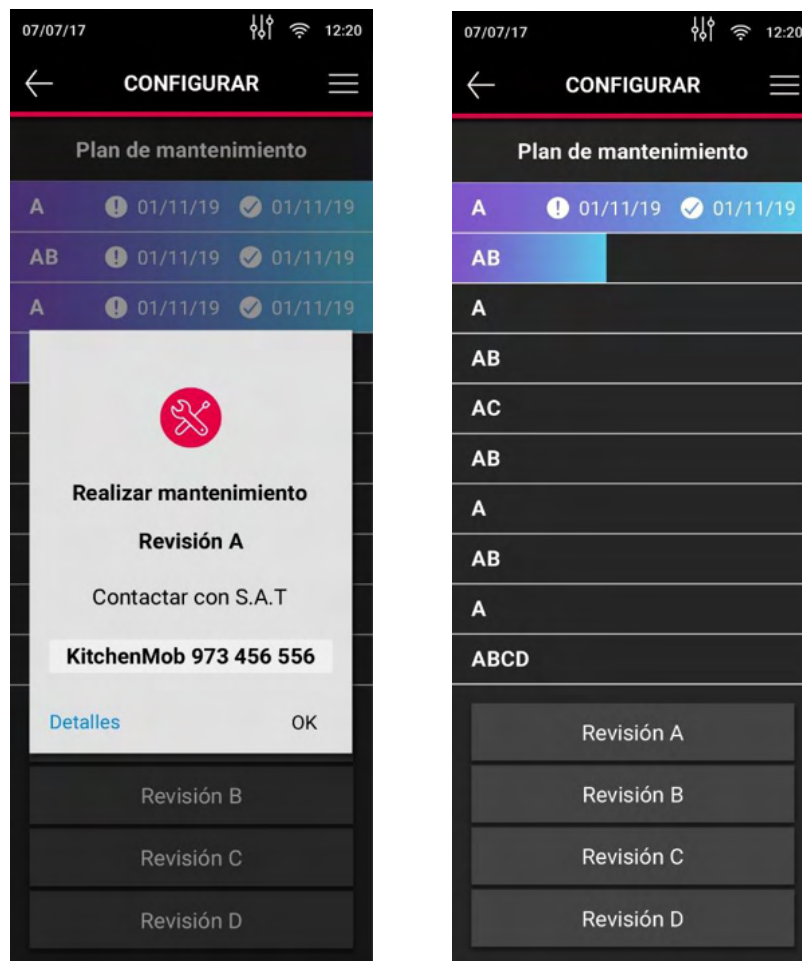


**This function will only be activated in time-controlled cooking.**

- The energy-saving option optimizes certain functions and improves the energy efficiency of the oven.

### 7.8.6. Maintenance

The Mychef combi oven has a preventive maintenance plan that will extend the life of the oven and its operation in optimal conditions. Depending on the hours of use, the user interface will show which maintenance plan to follow, and the technical service contact you should contact.



**Figure 46. Maintenance program screens**

The right screen shows the maintenance plans, pressing the review buttons displays the required activities to be performed.

The top bar shows the progress in operating hours associated with servicing. Once the revision has been carried out, the date on which it was carried out will be indicated as shown in the image above.

**Check A:**

- Water hardness testing
- Cleaning cooling fans
- Electronic cleaning
- Cleaning of the drain tray
- Change of gasket and door adjustment

**Check B:**

- Temperature calibration
- Adjustment of the internal screws and bolts

**Check C:**

- Change of chimney pipes and drainpipes
- Change of solenoid valve for water injection
- Resistor contactor change

**Check D:**

- Engine change
- Change of resistance and seal
- Water injection pipe gasket replacement

### 7.8.7. Probe

This section allows you to display the oven temperature readings at different points.



**Figure 47. Check probe temperatures**

By clicking on each probe, it is possible to edit the values.

Register	Name	Parameter	Editable
00	Probe 1	Multipoint probe 1	Yes
01	Probe 2	Multipoint probe 2	Yes
02	Probe 3	Multipoint probe 3	Yes
03	Probe 4	Multipoint probe 4	Yes
04	Probe 5	Multipoint probe 5	Yes
05	Probe 6	Multipoint probe 6	Yes
06	Probe 7	SmartClima probe	Yes
07	Probe 8	Probe chamber	Yes
08	Probe 9	PCB temperature	Yes
09	Probe 10	Inverter temperature	Yes

**Table 8. Section P4, Probes**

Each register is associated to a temperature reading point of the oven, allowing to control different critical points of the oven.



***If the temperature of a sensor is higher than 350°C or lower than -50°C it means that the probe is not connected.***

### **7.8.8. System Analysis**

This submenu allows you to set up the oven by checking the basic points for correct operation.

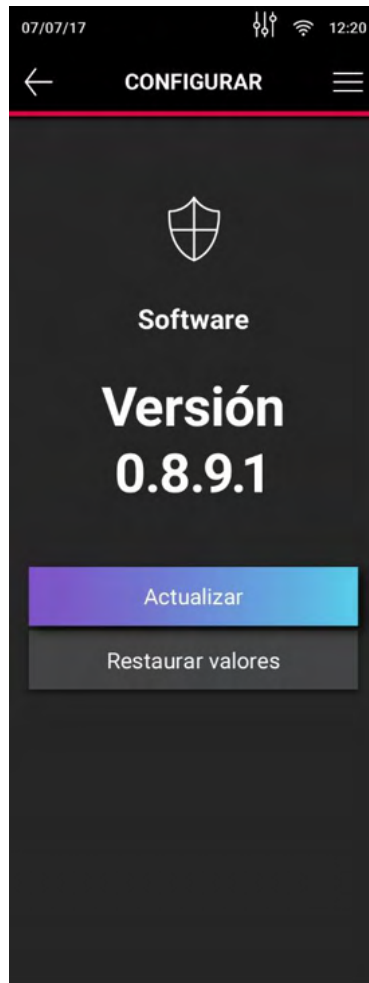
The user or the Technical Assistance Service (in the case of the first use and start-up of the oven) is guided through six steps to carry out the following checks:

- Lighting: check that the cooking chamber is correctly illuminated.
- Temperature: The system will preheat to detect possible anomalies.
- Water connection: Check that the connections of the hydraulic system have been made correctly to avoid any type of leakage.
- Door: by opening and closing the door, a problem will be detected in the sensor that controls the door.

The existence of any anomaly in any of the previous points will prevent the operation of the oven. Therefore, it will be necessary to carry out the necessary actions and repeat the check until the system analysis is satisfactory to continue.

### 7.8.9. System

System displays the software version of the device and the option to update or restore the factory settings of the system.



**Figure 48. System information**

The software can also be updated here. To do this, click on the Update button, and whenever there is an Internet connection, the system will be updated with the latest software version.

### 7.8.10. Restore factory default values

To do this, click on the Restore Values button. The restoration will start automatically.

All values shall be restored except for the oven type, the number of TSC channels, the self-cleaning type, the fan type and the statistical values of the oven.

### 7.8.11. Accounts

This option allows you to consult the data corresponding to the user of the oven and the Technical Support Service.

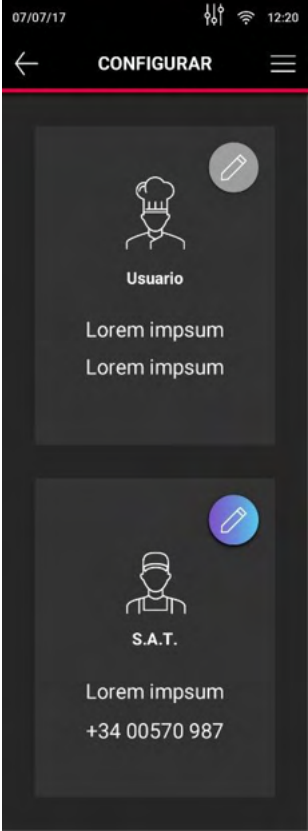


Figure 49. Consultation and configuration of accounts

### 7.8.12. USB

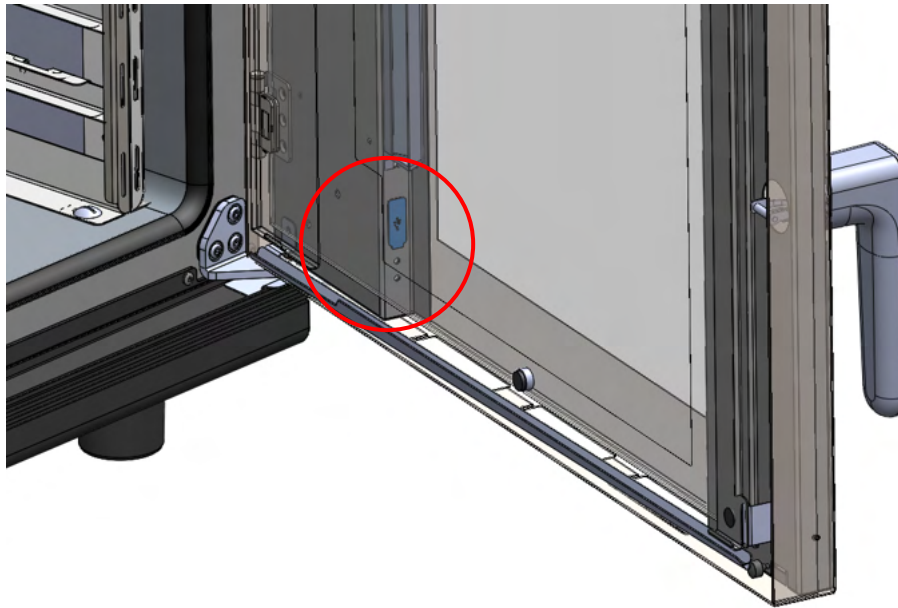
The equipment allows the loading and unloading of recipes and images in addition to HACCP data.



**Figure 50. USB file upload/download**

The equipment allows the recording of temperatures and events occurring during normal use. To record data, insert a memory into the USB connector in the lower right corner of the oven. To access it, it is necessary to open the door and then open the glass.





**Figure 51. USB connector housing**

They can be viewed from any computer.



***The USB device system must always be FAT32.***

### **7.8.13. Consumption**

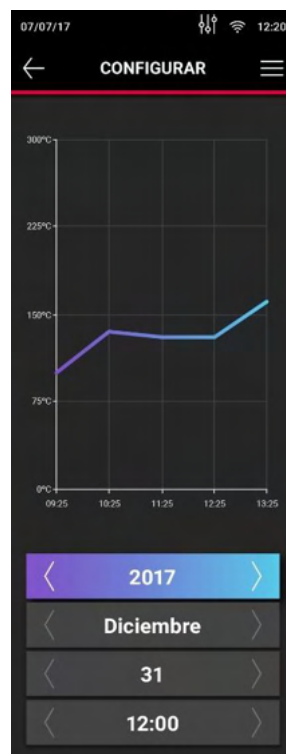
In this section is possible to consult the data corresponding to the energy consumption of the oven and HACCP.

In order to know the water and energy consumption, it is possible to delimit the desired range, be it annual, monthly, daily or hourly.



**Figure 52. Consumption data**

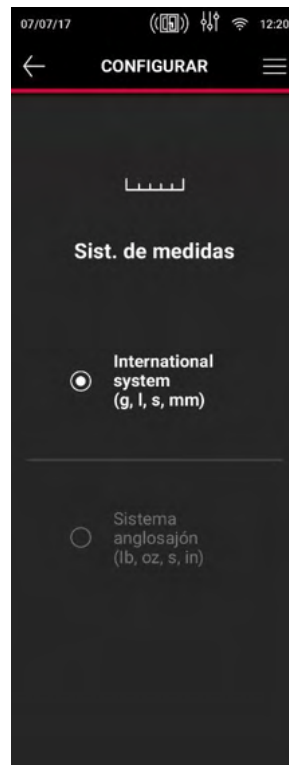
Similarly, by accessing the HACCP Data option and setting the desired range, it will be possible to display the graph corresponding to the HACCP data record.



**Figure 53. Consumption progress**

### 7.8.14. Measurement system

The oven configuration allows working both in the international measurement system and in the Anglo-Saxon system. By selecting one of the two options and pressing the back button, the configuration will be saved, and the system restored.



**Figure 54. Measurement system configuration**

### 7.8.15. Advanced settings

This section allows to consult the internal configuration parameters of the oven and facilitates the diagnosis of faults and malfunctions as well as its solution to the Technical Assistance Service.

Name	Parameter	Editable
Type	Oven type	No (TS)
Tsc	Number of TSC channels (0 - 4)	No (TS)
Autoclean	MyCare	No (TS)
FanConfig	Fan and inverter type	No (TS)
RelayTest	Relay test relays 1 to 15	No (TS)
GPIONTest	Test GPIOs	No (TS)
TSCTest	Test TSC	No (TS)
InverterTest	Test inverter	No (TS)
AutoReverseTemp	Auto-reverse activation temperature	No (TS)
HysteresisHeating	Temperature hysteresis	No (TS)
LogPeriod	Period between HACCP, in seconds	No (TS)
AutomaticRecovery	NightWatch	No (TS)
SmartClimaSetting	Humidity control settings	No (TS)
RelayRemap	Free relay remapping	No (TS)
ProbeRemap	Probe for temperature control in chamber	No (TS)
ErrorInhibit	Disable error checking	No (TS)
T_000_050	Working hours between 0°C and 50°C	No (TS)
T_050_100	Working hours between 50°C and 100°C	No (TS)
T_100_150	Working hours between 100°C and 150°C	No (TS)
T_150_200	Working hours between 150°C and 200°C	No (TS)
T_200_250	Working hours between 200°C and 250°C	No (TS)
T_250_300	Working hours between 250°C and 300°C	No (TS)
Rinse	Number of rinses	No (TS)
Clean1	Number of cleanings level 1	No (TS)
Clean2	Number of cleanings level 2	No (TS)
Clean3	Number of cleanings level 3	No (TS)
Clean4	Number of cleanings level 4	No (TS)
Door	Door opening statistics divided by 10	No (TS)
Error 0	Last error occurred	No (TS)
Error 1	Penultimate error occurred	No (TS)
Error 2	First to last error made	No (TS)
Error 3	Previous to the error 2	No (TS)
Error 4	Previous to the error 3	No (TS)
Error 5	Previous to the error 4	No (TS)
Error 6	Previous to the error 5	No (TS)
Error 7	Previous to the error 6	No (TS)

**Table 9. Advanced settings**

The parameters report a very wide range of features ranging from the type of oven to fan configuration, etc. and also allow the technical service to perform tests and tests to ensure perfect operation.

Statistical logs primarily store runtime, cycle repetition, and wear and tear values of certain elements to monitor the life cycle and maximize the efficiency of all oven components.

### 7.8.16. NightWatch

NightWatch allows the oven to automatically continue cooking after a power failure. This functionality is especially useful for unattended cooking.



***This function will only continue with cooking in the event of a power failure and subsequent recovery of the power supply.***



***This function can be disabled by your dealer. Make sure that you fully understand the risks involved in using it.***

When a cut occurs and the power supply is subsequently restored, the oven recovers the current cooking (if any) and continues it with the same parameters as before the power failure.

The following figure shows the oven display when the power is restored and just before starting NightWatch functionality. Pressing the circular button START/STOP key in this state will cancel automatic recovery.

If it is not cancelled, the Mychef oven automatically checks the temperature of the cooking chamber. If the temperature is below 56°C there may be a risk of bacterial contamination. In this case, the oven will continue cooking but will display error 28 when pressing the circular button START/STOP button to end the cooking cycle. In this case, the final user shall decide the fate of the food, taking into account the risks of possible bacterial contamination.



***To minimize risks, analyze the food after such a low temperature warning when it is automatically recovered from cooking, or discard it (Error 28).***



***Use the HACCP data record to always check cooking processes.***

### 7.8.17. Errors and alarms

During the preparation and execution of any of the programs available in the oven, errors may occur. If an error occurs in the system during use, it will be displayed in the error list.

The table below shows the different errors and alarms, as well as possible solutions to them.

<b>Error</b>	<b>Internal definition</b>	<b>Notes</b>
<b>0</b>	NO ERROR	No error.
<b>1</b>	ERROR GENERAL PURPOSE INPUT	General error input. Not used.
<b>2</b>	ERROR OVERTEMPERATURE	General over temperature input. Not used.
<b>3</b>	ERROR OVERTEMPERATURE PCB	Over temperature PCB. Check that the cooling fans of the electronics are working properly, that there is sufficient space between the rear and the wall, and that the ambient temperature is not too high.
<b>4.1</b>	ERROR COMMUNICATION	Communication between boards is not responding. Check the cable connecting the power board and control board.
<b>4.3</b>	ERROR COMMUNICATION	Communication between relay board and inverter is not responding. Check the cable connecting both components. Check if the inverter communication LED blinks.
<b>4.7</b>	ERROR HOOD	Communication between boards is not responding. Check the wiring.
<b>4.8</b>	ERROR PROOFER	Communication between boards is not responding. Check the wiring.
<b>4.9</b>	ERROR STATIC OVEN	Communication between boards is not responding. Check the wiring.
<b>5</b>	ERROR EEPROM	Communication processor and EEPROM does not work. Check the control board.
<b>6</b>	ERROR MOTOR	Motor error. Check motor wiring. Overtemperature on the motor. Motor failure.
<b>7</b>	ALARM WATER	No water detected. Ensure that the water supply is connected correctly.
<b>8</b>	ERROR WASHING	No detergent detected. Not used.
<b>9</b>	ERROR PROBE1 TEMP SENSOR NOT CONNECTED	External probe not connected. Check the external probe and connector.
<b>10</b>	ERROR PROBE1 TEMP SENSOR SHORTED	External probe short-circuited. Check the external probe and connector.
<b>11</b>	ERROR PROBE2 TEMP SENSOR NOT CONNECTED	External probe not connected. Check the external probe and connector.

<b>12</b>	ERROR PROBE2 TEMP SENSOR SHORTED	External probe short-circuited. Check the external probe and connector.
<b>13</b>	ERROR PROBE3 TEMP SENSOR NOT CONNECTED	External probe not connected. Check the external probe and connector.
<b>14</b>	ERROR PROBE3 TEMP SENSOR SHORTED	External probe short-circuited. Check the external probe and connector.
<b>15</b>	ERROR PROBE4 TEMP SENSOR NOT CONNECTED	Reserved. Not used.
<b>16</b>	ERROR PROBE4 TEMP SENSOR SHORTED	Reserved. Not used.
<b>17</b>	ERROR PROBE5 TEMP SENSOR NOT CONNECTED	Reserved. Not used.
<b>18</b>	ERROR PROBE5 TEMP SENSOR SHORTED	Reserved. Not used.
<b>19</b>	ERROR PROBE6 TEMP SENSOR NOT CONNECTED	Reserved. Not used.
<b>20</b>	ERROR PROBE6 TEMP SENSOR SHORTED	Reserved. Not used.
<b>21</b>	ERROR PROBE7 TEMP SENSOR NOT CONNECTED	Reserved. Not used.
<b>22</b>	ERROR PROBE7 TEMP SENSOR SHORTED	Reserved. Not used.
<b>23</b>	ERROR PROBE8 TEMP SENSOR NOT CONNECTED	Chamber probe not connected. Check probe and wiring.
<b>24</b>	ERROR PROBE8 TEMP SENSOR SHORTED	Short circuit chamber probe. Check probe and wiring.
<b>25</b>	ERROR PROGRAM NOT TERMINATED	Reserved. Not used.
<b>26</b>	ERROR CLEANING PROGRAM NOT TERMINATED	The oven has been switched off by executing a self-cleaning program. Perform a rinsing program.
<b>27</b>	ERROR CLEANING TEMPERATURE TOO HOT	Oven temperature during a self-cleaning program has risen above a maximum temperature.
<b>28</b>	ALARM RECOVERY TEMP TOO LOW	The oven has recovered from a power outage, and the temperature in the chamber was below 56°C. Risk of bacterial contamination. Dispose of or test product.
<b>29.XXXX</b>	INVERTER ERROR	Inverter error. Consult code with the technical service.
<b>30.XX</b>	GAS SAFETY ERROR	Gas safety error. Consult code with the technical service.

**Table 10. Errors, alarms, and possible solutions**



***Always run a self-cleaning or rinsing program when Error 26 occurs.***

Check whether errors can be removed by your own means, or if not, contact your service representative.



## 8. MAINTENANCE



***Any ordinary maintenance operation must be carried out after disconnecting the equipment from the electricity, water, and gas supply (in case the oven is powered by gas). Except for the MyCare self-cleaning process as it requires the oven to be running.***



***For any maintenance operation, it will be imperative to use the appropriate protective equipment.***



***In the event of the replacement of any part by a technical service, it is imperative to disconnect the equipment from its electrical, water and gas supply (in case the oven works with gas).***

### 8.1. Cleaning

It is the responsibility of the owner to carry out regular maintenance and cleaning. To maintain the warranty, it must be possible to check that maintenance has been carried out correctly and according to the instructions detailed in this manual.

One of the important parts in the maintenance of the equipment is its cleaning. Therefore, the equipment should be cleaned more or less frequently depending on the area of the equipment.

Below is a table showing the frequency with which the different parts of the equipment should be cleaned.

<b>Part of the equipment</b>	<b>Frequency</b>
Inside the chamber	Daily
Compartment behind the suction plate	Daily
Door gasket	Daily
Equipment outer plates	Daily
Door water drain	Weekly
Interior-exterior door compartment	Weekly

**Table 11. Cleaning frequencies for Mychef ovens**

Regarding the exterior cleaning of the oven, it is strictly forbidden to use:

- Powder abrasive detergents
- Aggressive or corrosive detergents (For example: Sulfuric acid, Hydrochloric acid ...).
- Abrasive tools
- Cleaning equipment with pressurized water.
- Steam cleaning equipment.



***Any use of the elements described above is harmful to the equipment and could cause it to break and would void its warranty, Mychef disclaims any responsibility in this case.***

### 8.1.1. Cooking chamber

Mychef iBAKE ovens feature self-cleaning as standard (MyCare) for automatic and unsupervised cleaning of the cooking chamber. MyCare enables greater energy savings with lower detergent consumption and fewer toxic emissions. Therefore, Mychef only recommends the use of CleanDuo tablets for this process.

In Figure 34 of this manual, it is possible to see the location of the CleanDuo tablet, the number of tablets to be used per wash, depending on the number of trays of this:

<b>Mychef oven models</b>	<b>Number of tablets to use</b>
Mychef iBAKE 4 600x400	1
Mychef iBAKE 6 600x400	2
Mychef iBAKE 10 600x400	2



***Before starting any cleaning program, trays, grids, grills, probes, or other accessories that may be inside the chamber must be removed.***



***Never use cold water to wash the inside of the cooking chamber when it is at temperatures above 70°C. Thermal contrast is harmful to equipment and would void the equipment warranty.***

### 8.1.2. Stainless steel exterior surfaces

Use only a soft cloth with a little soapy water to clean the stainless-steel exterior surfaces. Rinse and dry carefully.



***Do not clean the exterior of the equipment after use, wait until the surfaces are at room temperature.***

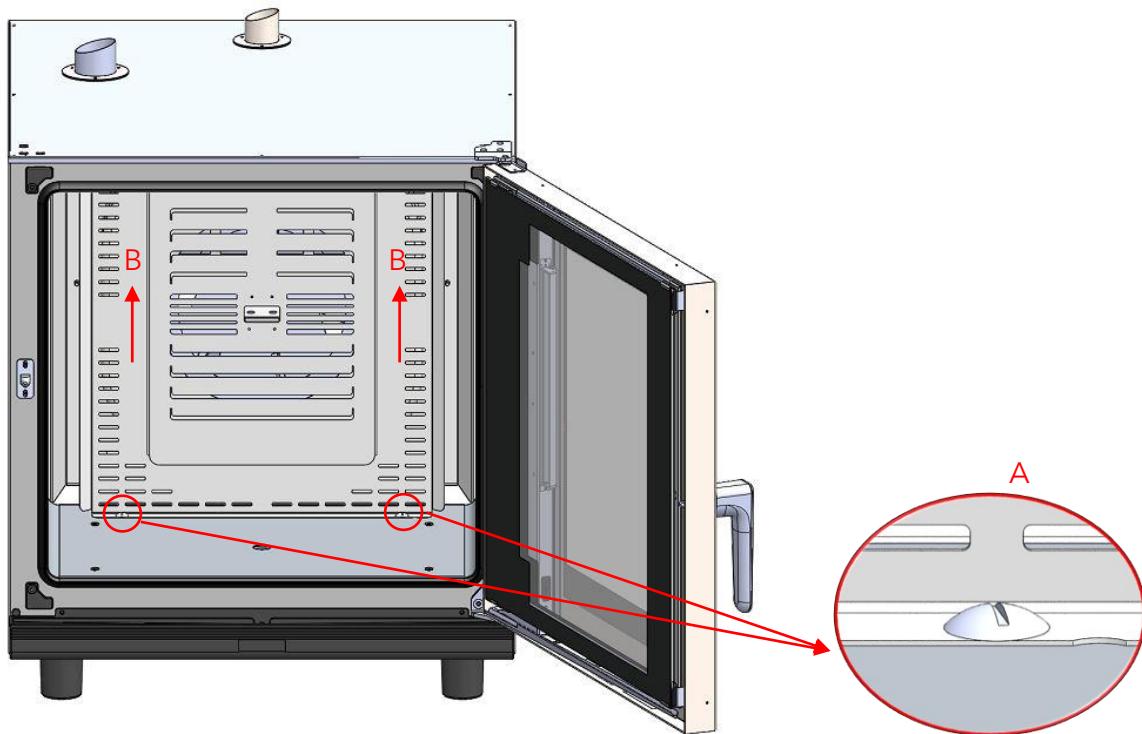
### 8.1.3. Fan and heat exchanger zone

The part that separates the cooking chamber with the fan and heat exchanger can be removed to clean this area. In order to remove the protector, it is necessary to unscrew the two lower screws that hold the protection to the bottom of the chamber (A), once these screws are free, lift the protection and extract it to the outside (B).

Only use a soft cloth with a little soapy water to clean the interior surfaces. Rinse and dry carefully.



***Before removing the fan protector, the tray guides must be removed.***



**Figure 55. Fixing system of the fan and exchanger protector**

#### 8.1.4. Plastic outer surfaces and control panel

To clean these more delicate surfaces (support of the control and the control itself) only a very soft cloth and a cleaning product for delicate surfaces should be used.



***Take special care with the control panel, Mychef will not be responsible for damage caused to this element if it is not cleaned properly.***

With regard to the water trap, it allows the drops of water that may fall due to condensation of the steam from the inner door to go to the drain, for this reason it is important to keep this water trap clean and unobstructed.

Remove any bits of food that may have fallen before cleaning. Then, clean this piece with a cloth soaked in water and finally rinse with plenty of water.

#### 8.1.5. Door gasket

Once the chamber cleaning has been completed, the washing process will be followed with the gasket that ensures the chamber is watertight. It is important that this part of the oven is clean and does not have any embedded pieces of food so that it can seal the chamber well and that heat, water or steam cannot escape when it is in operation.

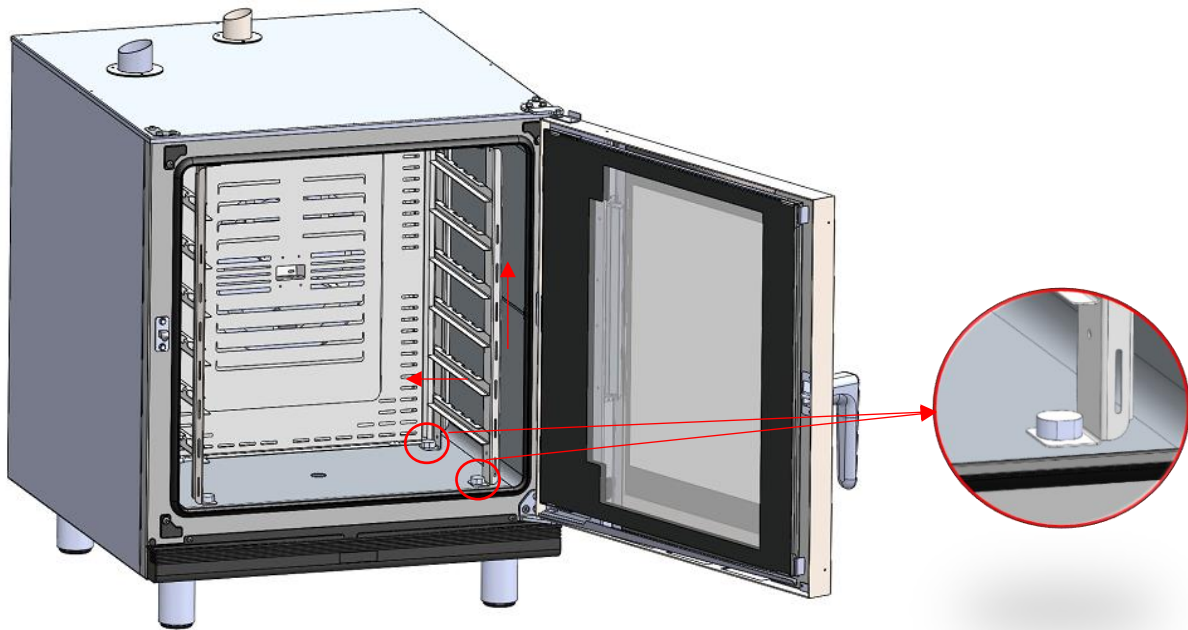
To clean this rubber gasket, just a cloth dampened with soapy water is enough. Then rinse the entire area and dry well.

The door gasket should not be removed from its contour for cleaning, it should only be removed when it has to be replaced, in case of replacement it can be done manually without the help of any tool.

### 8.1.6. Tray Support

The tray supports located on both sides of the cooking chamber are easy to remove, you simply have to manually unscrew the four knobs, two on each side, then raise the guide and separate it from the upper fastening.

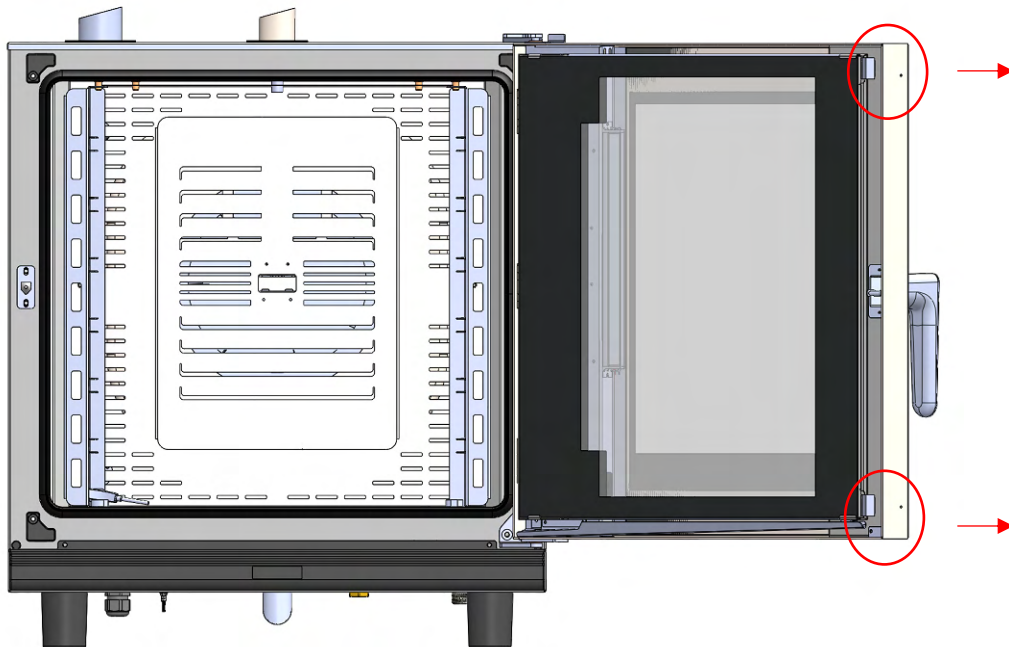
Only use a soft cloth with a little soapy water to clean the stainless-steel guide bodies. Do not use abrasive elements, rinse and dry carefully.



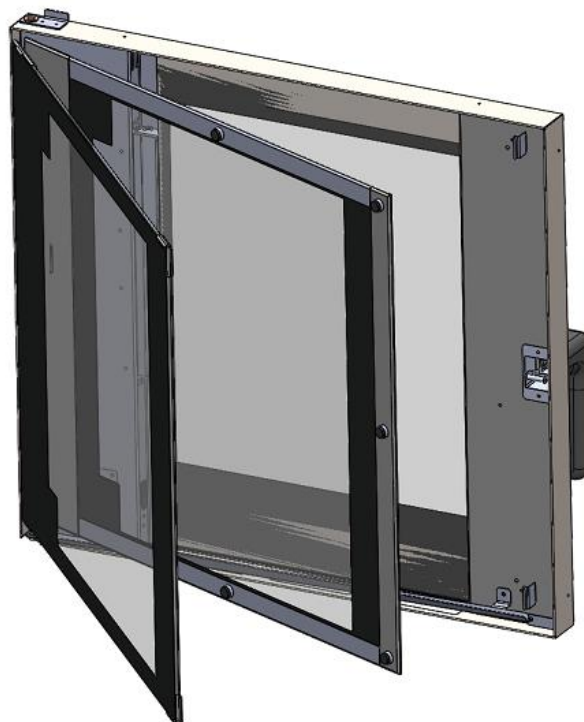
**Figure 56. Detail of the extraction process of the guides' structure**

### 8.1.7. Door glasses

Mychef iBAKE ovens are equipped with a high thermal efficiency door with three glasses to reduce heat losses to the maximum. In order to clean these three glasses and the door itself, the outer door must be opened and the clips that hold the two glasses open.



**Figure 57. Detail of glass fastening clips**



**Figure 58. Open glasses detail**

Since the inside of the glass in contact with the cooking chamber will be cleaned during the self-cleaning process. The remaining glasses, as they are not in contact with food, can only be cleaned with a soft cloth with glass cleaning liquid.

Once these glasses have been cleaned, close the inner door with the two glasses to the door and fix it with the clips.

No tools are required for this process, the staples can be released with your own hands.



***Do not use the hand shower accessory on the door glass while it is hot, there is a risk of breakage due to thermal shock.***

## **8.2. Periods of inactivity**


If the Mychef oven is not used for long periods of time, the following precautions should be followed:

- Disconnect the equipment from the electricity, water, and gas supply (only if it is a gas model).
- To avoid damage to the exterior and interior parts of the oven, apply Vaseline oil with the help of a soft cloth to all stainless-steel surfaces.
- After the period of inactivity, before the first use, thoroughly clean all the parts that are specified in section 8.1.
- Once thoroughly cleaned, reconnect the electricity, water and gas supply (in the case of a gas model).
- Mychef recommends subjecting the equipment to a review by an authorized technical service before being used again, in this way it ensures that the equipment is in perfect condition.

## **8.3. Disposal at the end of the useful life**

In accordance with Royal Decree 110/2015 of BOE No. 45, February 21, 2015, on waste electrical and electronic equipment (WEEE), and according to the directive of the European Parliament 2012/19 / EU.



The following symbol  specifies that the product that has been sold after August 13, 2005, and that, at the end of its useful life, should not be disposed together with other waste, but separately. All equipment is made of recyclable metal materials in a percentage greater than 90% by weight.

The equipment should be rendered useless by removing the power cord and any compartment and cavity closing devices. At the end of the useful life of Mychef ovens, it is

necessary to adopt all the necessary management measures to reduce the negative impact on the environment and make a more efficient use of resources, adhering to the principles of prevention and preparation for reuse, recycling, and recovery. It is recalled that the improper or incorrect disposal of the product entails the application of the sanctions provided by current legislation.

### 8.3.1. Information on disposal in Spain

In Spain WEEE devices must be delivered:

- In municipal cleaning points.

### 8.3.2. Information on disposal in the European Union

The Community Directive on WEEE equipment has been incorporated differently in each country of the European Union, so in the case of disposal of the equipment, we recommend that you inform the local authorities or your distributor about the method of correct disposal of our ovens.

## 8.4. Preventive maintenance

Mychef ovens are designed for intensive and long-lasting operation. For this to happen, in addition to regular cleaning tasks, preventive maintenance must be carried out. This preventive maintenance is specifically designed to prolong the life of your Mychef oven, minimize energy and water usage, and ensure excellent cooking quality without interruption.

This maintenance program is segmented into four types of service, A, B, C and D, which must be carried out approximately every year or 2,000 working hours, whichever comes first. For Mychef iBAKE models, the integrated software will automatically notify you of the periodic reviews to be carried out, indicating in detail the components to be inspected or replaced.



***These periodic reviews must be carried out every 2,000 hours of work or every year, whichever comes first.***



***These periodic checks must be carried out by an authorized technical service.***

The following table shows the operations to be performed on Mychef ovens at each of the revisions. The table is circular, and from 20.000h of use or 10 years would start counting again on the left of the table. That is to say, at 22.000h it would correspond to revision A of 2.000h.



Mychef maintenance program		2000	4000	6000	8000	10000	12000	14000	16000	18000	20000
Review A	Firmware update	X	X	X	X	X	X	X	X	X	X
	Water hardness test	X	X	X	X	X	X	X	X	X	X
	Cooling fans cleaning of	X	X	X	X	X	X	X	X	X	X
	Electronic cleaning	X	X	X	X	X	X	X	X	X	X
	Drainage tray and siphon cleaning	X	X	X	X	X	X	X	X	X	X
	Changing the gasket and adjusting the door	X	X	X	X	X	X	X	X	X	X
	Ionization rated current check *	X	X	X	X	X	X	X	X	X	X
	Check that the gas inlet pressure is correct *	X	X	X	X	X	X	X	X	X	X
	Control of CO-CO <sub>2</sub> emissions according to model *	X	X	X	X	X	X	X	X	X	X
Check the gas system for leaks *	X	X	X	X	X	X	X	X	X	X	
Review B	Pathogen inactivator replacement (depending on models)		X		X		X		X		X
	Temperature calibration		X		X		X		X		X
	Adjustment of internal screws		X		X		X		X		X
Review C	Change of chimney and drain pipes					X					X
	Change of solenoid valve for water injection					X					X
	Change of resistance contactor (only models without TSC)					X					X
Review D	Change of motor										X
	Change of resistance and gasket										X
	Change of internal gaskets										X

**Table 12. Periodic maintenance table**

\*Only gas models



**Regular maintenance ensures that your oven always works as designed.**



**Periodic maintenance must be accredited for warranty validity purposes.**



**Before any handling for maintenance or repair, the equipment must be disconnected from the power supply.**



**If the power cable is damaged, it must be replaced by your service department or similarly qualified personnel in order to avoid risks.**