



Client _____ Quantity _____
 Project _____ Position _____

Vision Industry W100K F

Model: W100KFR-2D

Cod: W81220212001

Technical data

Max capacity:	2 trolleys GN2/1, EN60x80
Temperature range:	-40°+65°C
Refrigerant unit:	Remote
Yield +90 / +3:	320 Kg
Yield +90 / -18:	240 Kg
Cooling gas:	R404/R452
Defrost:	Forced air
Valve:	Electronic expansion valve
Dimensions:	1600×2600×2510 mm
Packing dimensions:	N°2× 2755×1730×1690 mm
Gross weight:	850 Kg
Voltage:	400-415 V - 50-60 Hz
Total rate:	6540 W
Absorbed Current:	23,66 A
Cooling capacity:	26340 W*
*:	Evap. -10°C Cond. +45°C

Features

Functions:	Blast chilling, shock freezing, thawing, proving and retarder prover, holding, steam sanitizing, manualcycle
Control:	7" touch screen display with USB port
Doors:	Dictator closure to absorb sudden changes in pressure when opening and closing doors
Door gasket:	Magnetic, triple chamber and easily replaceable
Core probe:	Needle probe with 1 reading point, quick-release and easily replaceable
Insulation:	100 mm thickness - CFC/HCFC free
Exterior/interior finishing:	Internal and external in "linen canvas" steel
Inner corners:	Rounded base 20 mm
Handle:	In AISI 304 stainless steel

Remote unit technical data

Voltage:	400-415 V 3N - 50 Hz
Cooling gas:	R404-R452a
Gross weight:	418 Kg
Dimensions:	1650×1050×876 mm
Cooling capacity:	Evap. -10°C Cond. +45°C

COSMO - wi-fi control

Cosmo è l'innovativa tecnologia wi-fi che permette di connettere e monitorare costantemente da smartphone l'abbattitore VISION. VISION può essere anche un Cosmo hub e consentire la supervisione remota di tutti gli apparecchi Coldline a lui collegati. Dall'app Cosmo potrai controllare in tempo reale le condizioni di funzionamento di ogni macchina e ricevere alert in caso di funzionamento anomalo. Cosmo confronta costantemente le prestazioni dell'apparecchio con quelle ideali e, in caso di differenze significative, suggerisce la manutenzione necessaria. Il software VISION può ricevere gli aggiornamenti periodici rilasciati, con le più recenti funzionalità sviluppate.



Technical draw

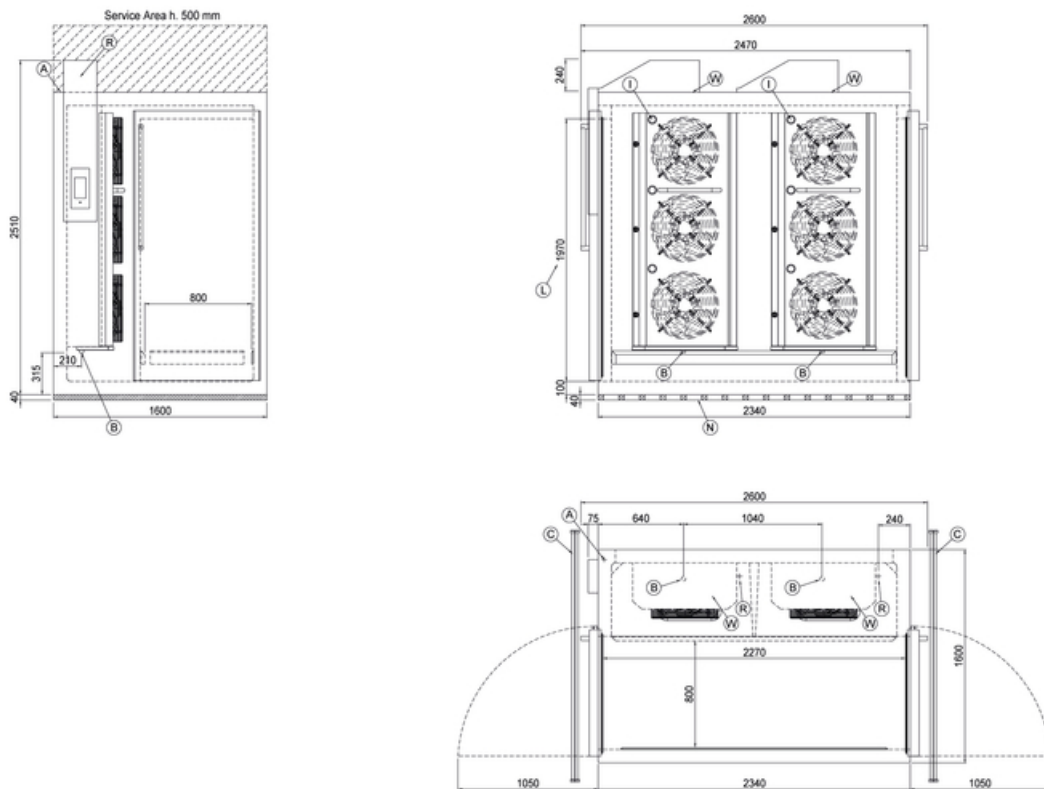

- A:** Power supply cable outlet
- C:** Floor grid for condensate drainage
- L:** Door clear opening dimension

- B:** Condensation water drain
- I:** Internal led lighting
- N:** PVC ventilation profiles

In order to constantly offer the best possible products we reserve the right to make changes on technical specifications without incurring any obligation for equipment previously or subsequently sold.